

Basic Pedestal



Self Priming Centrifugal Pump

Model 02C3-B

Size 2" x 2"

PUMP SPECIFICATIONS

Size: 2" x 2" (51 mm x 51 mm) NPT – Female.

Casing: Gray Iron 30.

Maximum Operating Pressure 34 psi (234 kPa).*

Enclosed Type, Five Vane, Impeller: Copper Alloy C83600.

Handles 11/32" (8,7 mm) Diameter Spherical Solids.

Impeller Shaft: Carbon Steel 1215.

Replaceable Vane Plate: Gray Iron 30.

Bearing Housing: Gray Iron 30.

Intermediate: Gray Iron 30.

Thrust and Radial Bearings: Sealed Single Row Ball.

Gaskets: NC710 Cork w/Nitrile Binder.

O-Ring: Fluorocarbon (DuPont Viton® or Equivalent).

Hardware: Standard Plated Steel.

Optional Equipment: All Iron Construction. Ductile Iron Casing. Type 9 Mechanical Self-Lubricated Seal w/Carbon and Ceramic Faces and PTFE Elastomers.

**Consult Factory for Applications Exceeding Maximum Pressure and/or Temperature Indicated.*

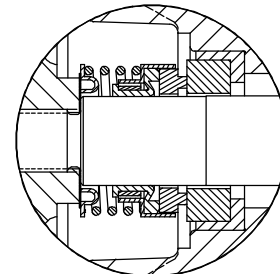
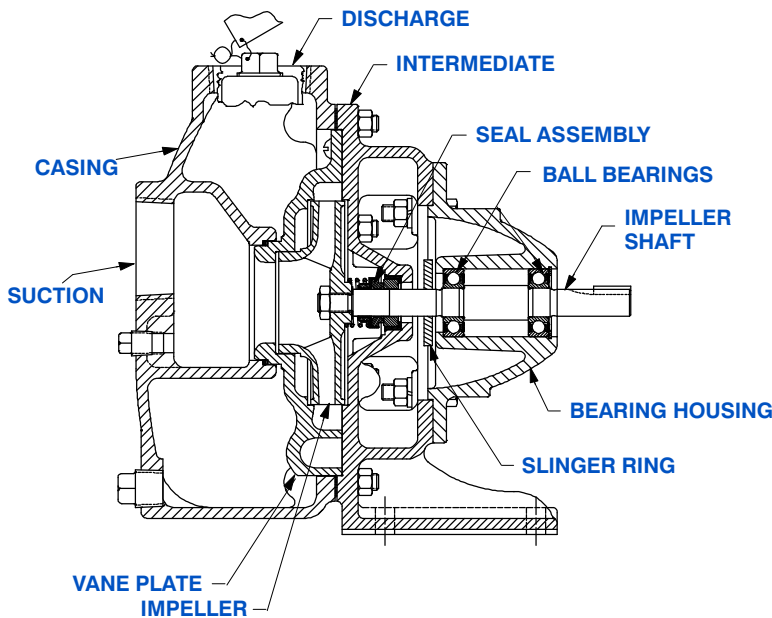

SEAL DETAIL

Type 21, Mechanical, Self-Lubricated. Carbon Rotating Face. Ni-Resist Stationary Face. Fluorocarbon Elastomers (DuPont Viton® or Equivalent). Stainless Steel 18-8 Cage and Spring. Maximum Temperature of Liquid Pumped, 160°F. (71°C).*



GORMAN-RUPP PUMPS

www.grpumps.com

Specifications Subject to Change Without Notice

Printed in U.S.A.

Specification Data

SECTION 30, PAGE 325

APPROXIMATE
DIMENSIONS and WEIGHTS

NET WEIGHT:
SHIPPING WEIGHTS:
EXPORT CRATE:

50 LBS. (22,6 KG.)
55 LBS. (24,9 KG.)
2.3 CU. FT (0,06 CU. M.)

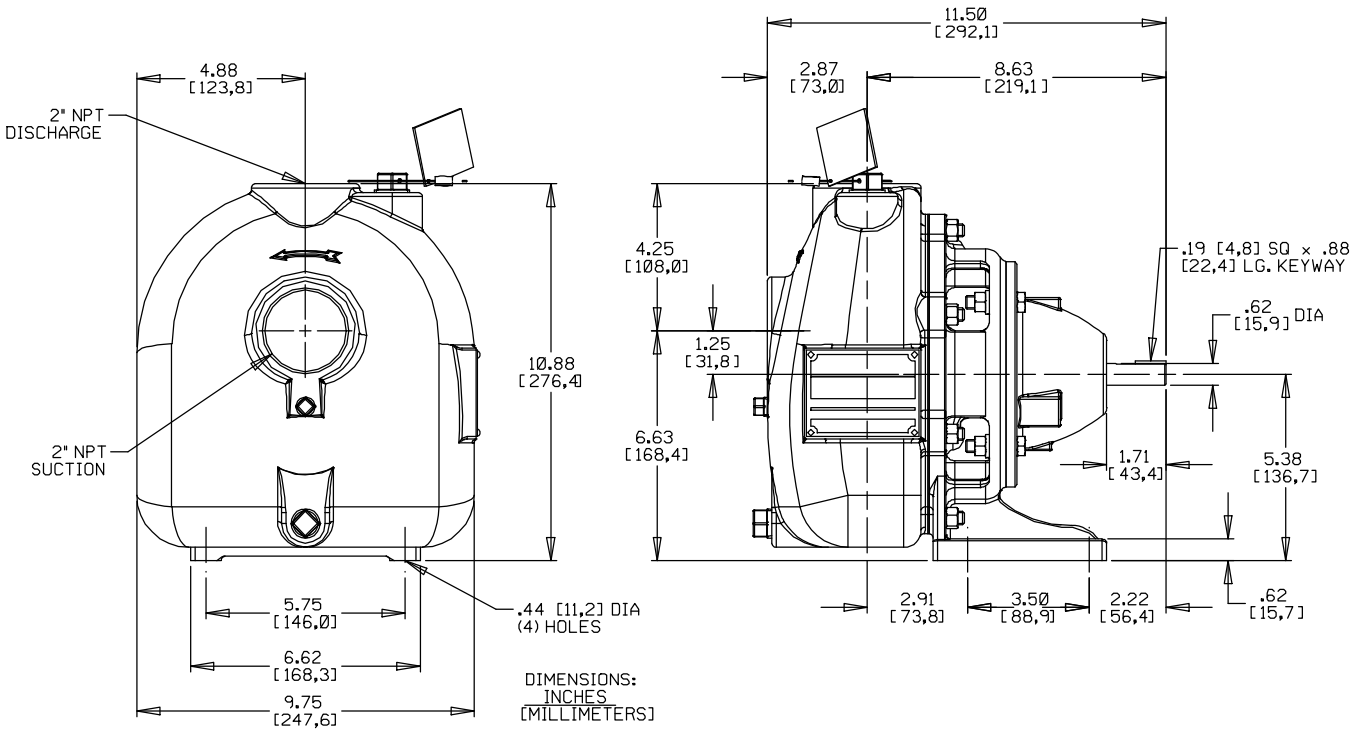

PERFORMANCE
BASED ON
PETROLEUM

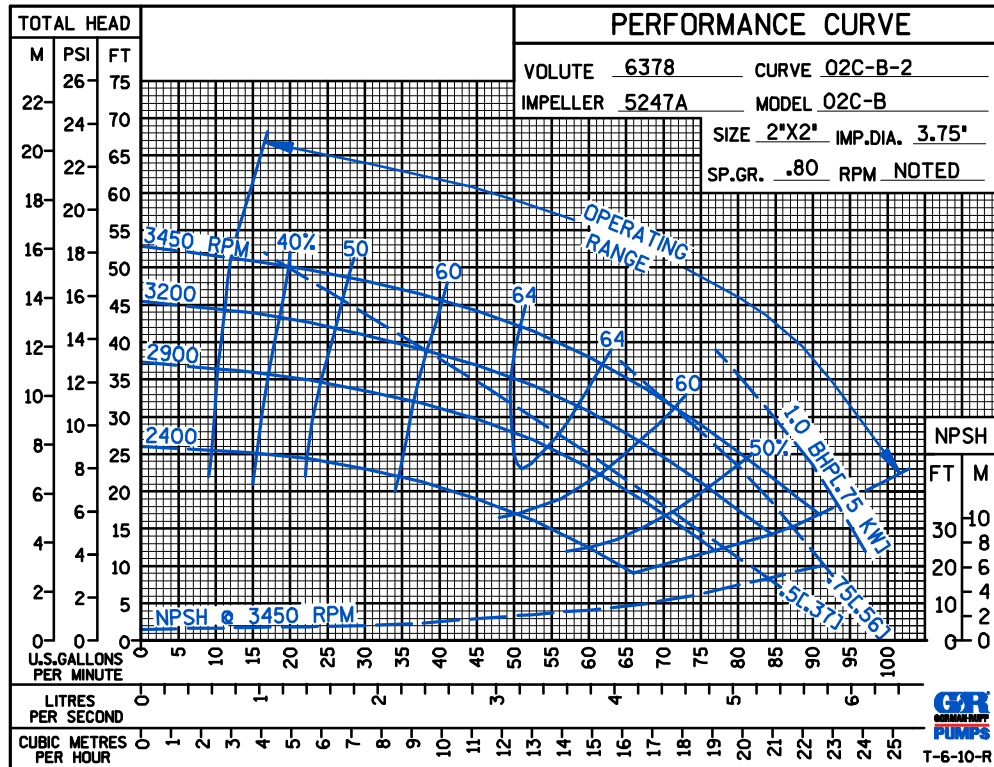

GORMAN-RUPP PUMPS

www.grpumps.com

Specifications Subject to Change Without Notice

Printed in U.S.A.

PERFORMANCE
BASED ON
WATER

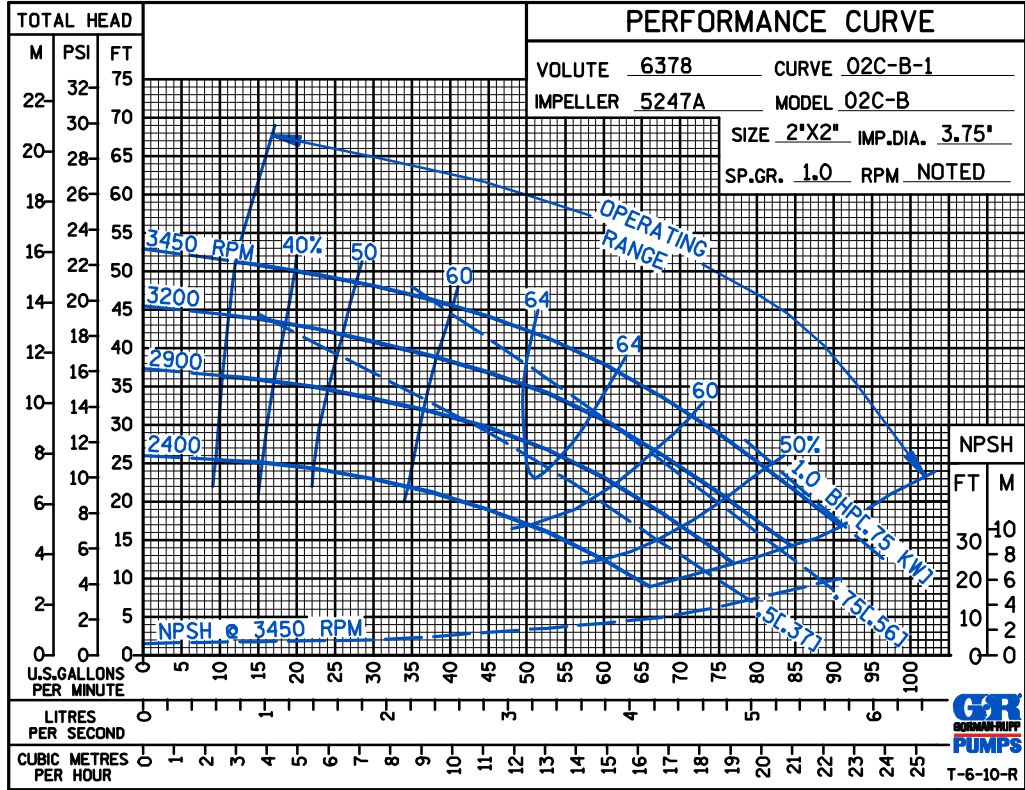

50 HERTZ
PERFORMANCE
BASED ON
PETROLEUM

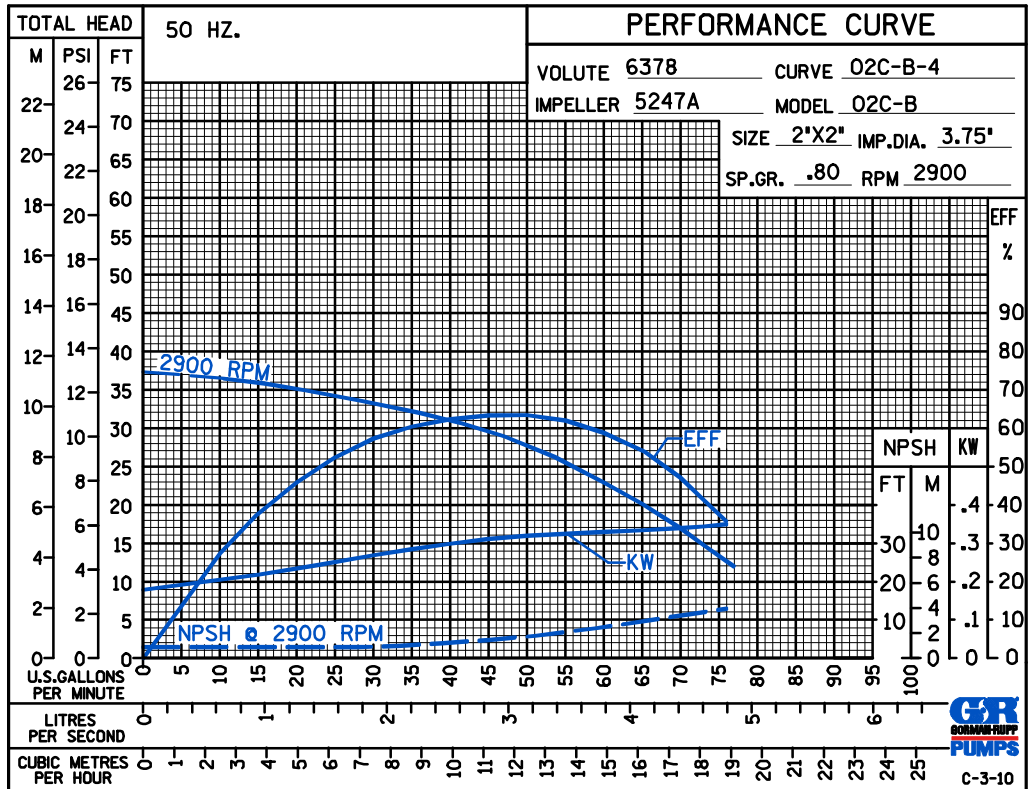

GORMAN-RUPP PUMPS

www.grpumps.com

Specifications Subject to Change Without Notice

Printed in U.S.A.

50 HERTZ
PERFORMANCE
BASED ON
WATER

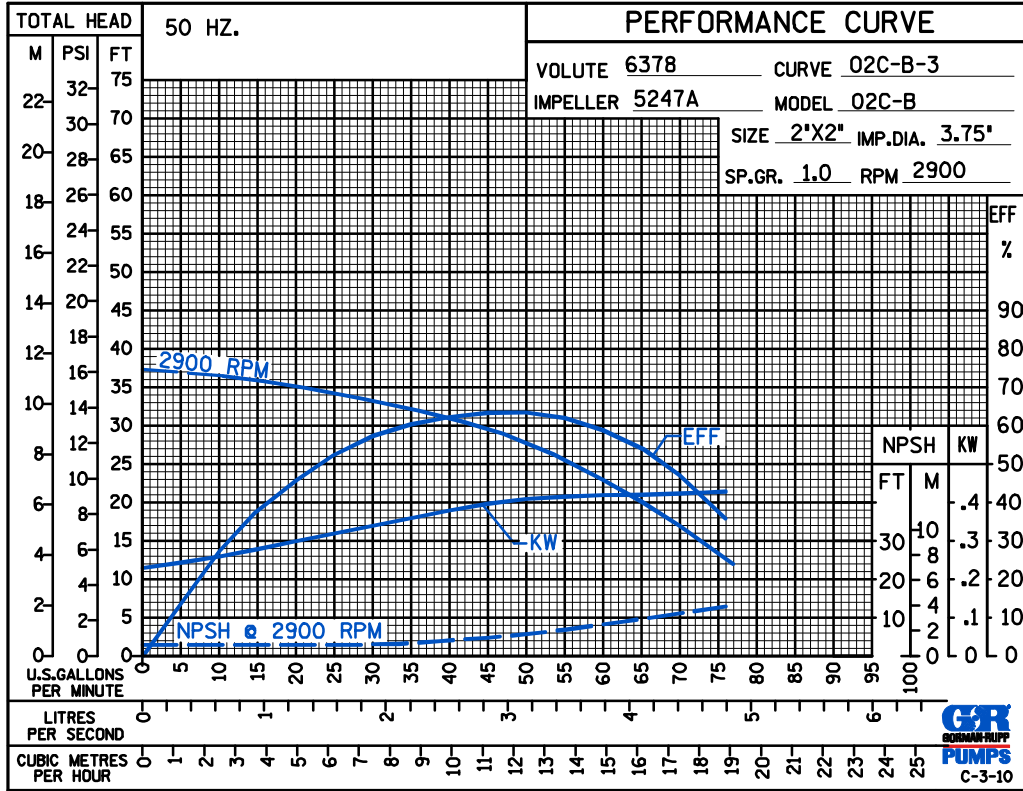

GORMAN-RUPP PUMPS

www.grpumps.com

Specifications Subject to Change Without Notice

Printed in U.S.A.