

Priming Assisted Centrifugal Pump



Model PAH10A60C-B

Size 12" x 10"



PUMP SPECIFICATIONS

- Size:** 12" x 10" (305 mm x 254 mm) Flanged.
- Casing:** Ductile Iron 65-45-12.
Maximum Casing Pressure 351 psi (2420 kPa).*
- Maximum Operating Pressure 250 psi (1723 kPa) at Temperatures up to 100° F (37° C) Based on System Component Limitations.*
- Enclosed Type, Four Vane Impeller:** Ductile Iron 80-55-06.
Handles 2" (50,8 mm) Diameter Spherical Solids.
- Suction Spool:** Gray Iron 30.
- Impeller Shaft:** Alloy Steel 4150M.
- Replaceable Wear Rings:** Ductile Iron 65-45-12.
- Pedestal:** Gray Iron 30.
- Seal Plate:** Ductile Iron 65-45-12.
- Shaft Sleeve:** Stainless Steel 303/304.
- Priming Chamber:** Gray Iron 30 Housing w/Stainless Steel Float and Linkage.
- Discharge Check Valve:** Ductile Iron Housing w/Buna-N Flapper.
- Radial Bearing:** Open Single Row Ball.
- Radial and Thrust Bearing:** Open Double Row Ball.
Bearing Cavity Lubrication: Lithium EP2 Grease.
- Gaskets:** Resistant Synthetic Rubber, Vegetable Fiber w/Compressed Synthetic Fibers.
- O-Rings:** Buna-N.
- Hardware:** Standard Plated Steel.
- Seal Cavity Oil Level Sight Gauges.**

**Consult Factory for Applications Exceeding Maximum Pressure and/or Temperature Indicated.*

- Standard Equipment:** Belt Driven Air Compressor
- Optional Equipment:** Base. NPT Threaded Flange Kit. Coupling. TEFC Motor. Suction Vacuum and Discharge Pressure Gauge Kit.

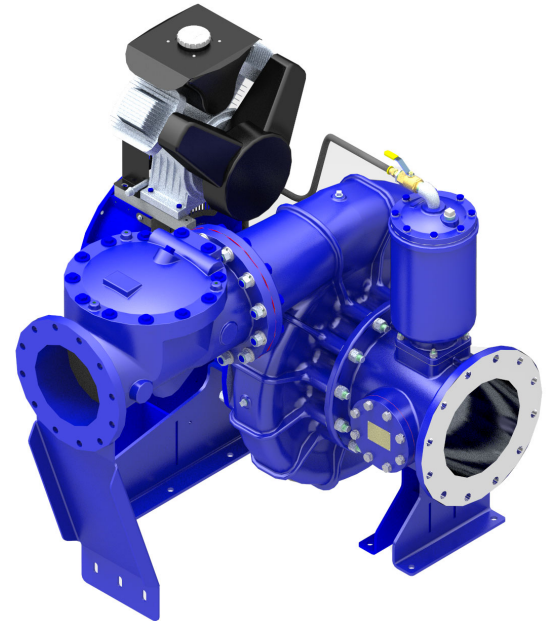

WARNING!

Do not use in explosive atmosphere or for pumping volatile flammable liquids.

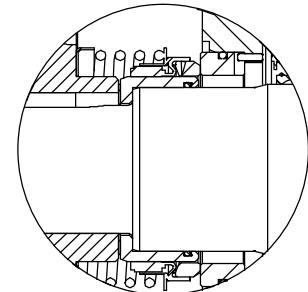
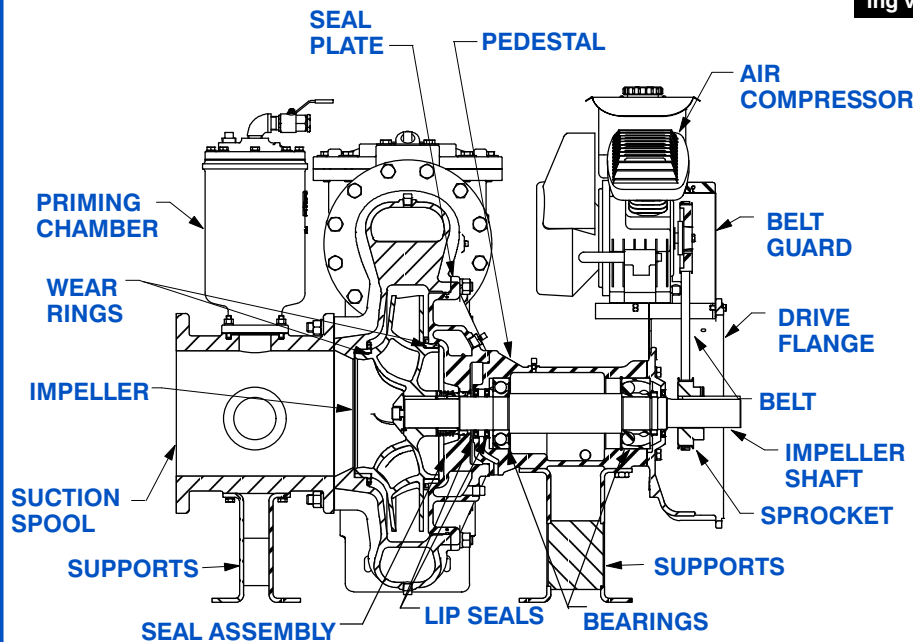

SEAL DETAIL

Mechanical, SAE 30 Non-Detergent Oil-Lubricated. Silicon Carbide Rotating Face and Stationary Seat. Fluorocarbon Elastomers (DuPont Viton® or Equivalent). Stainless Steel 316 Cage and Stainless Steel 18-8 Spring. Maximum Temperature of Liquid Pumped 160°F (71°C).*



GORMAN-RUPP PUMPS

www.grpumps.com

Specifications Subject to Change Without Notice

Printed in U.S.A.

Specification Data

SECTION 43, PAGE 520

APPROXIMATE DIMENSIONS and WEIGHTS

NET WEIGHT: 2540 LBS. (1152 KG.)
SHIPPING WEIGHT: 2900 LBS. (1315 KG.)
EXPORT CRATE SIZE: 156 CU. FT. (4,4 CU. M.)

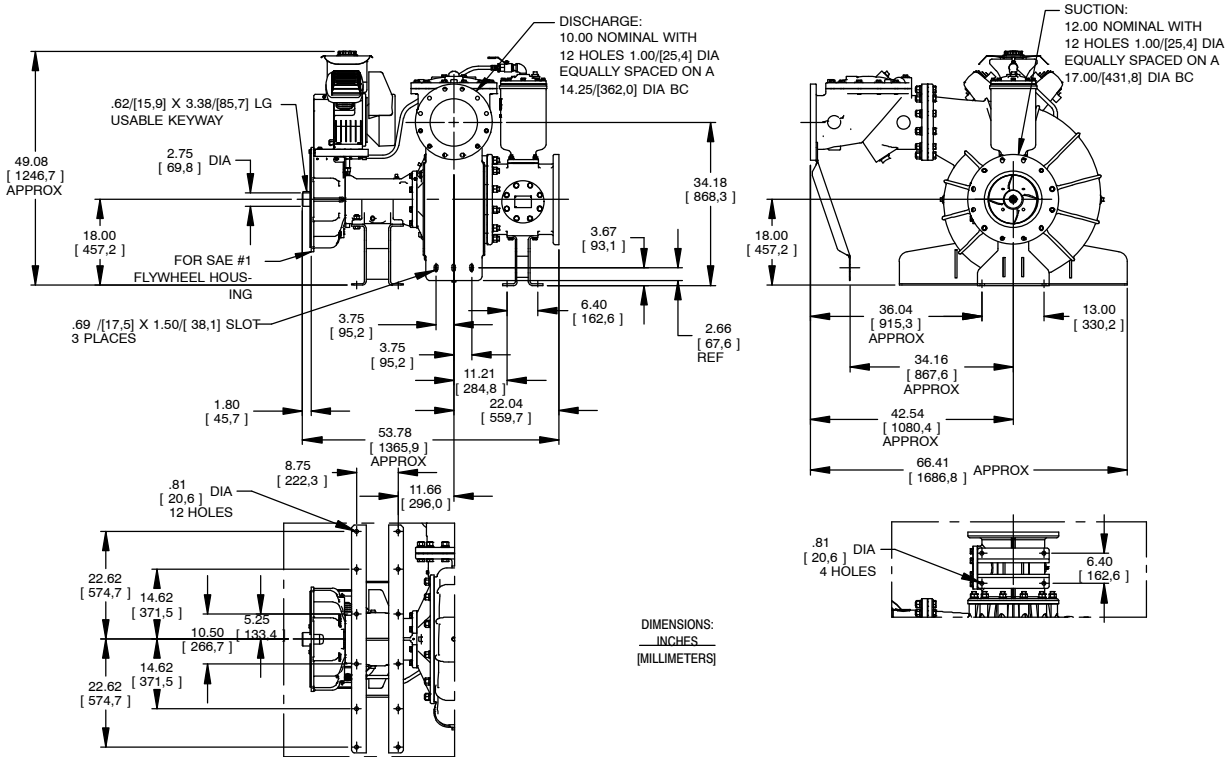

MULTI-SPEED CURVE PERFORMANCE BASED ON WATER

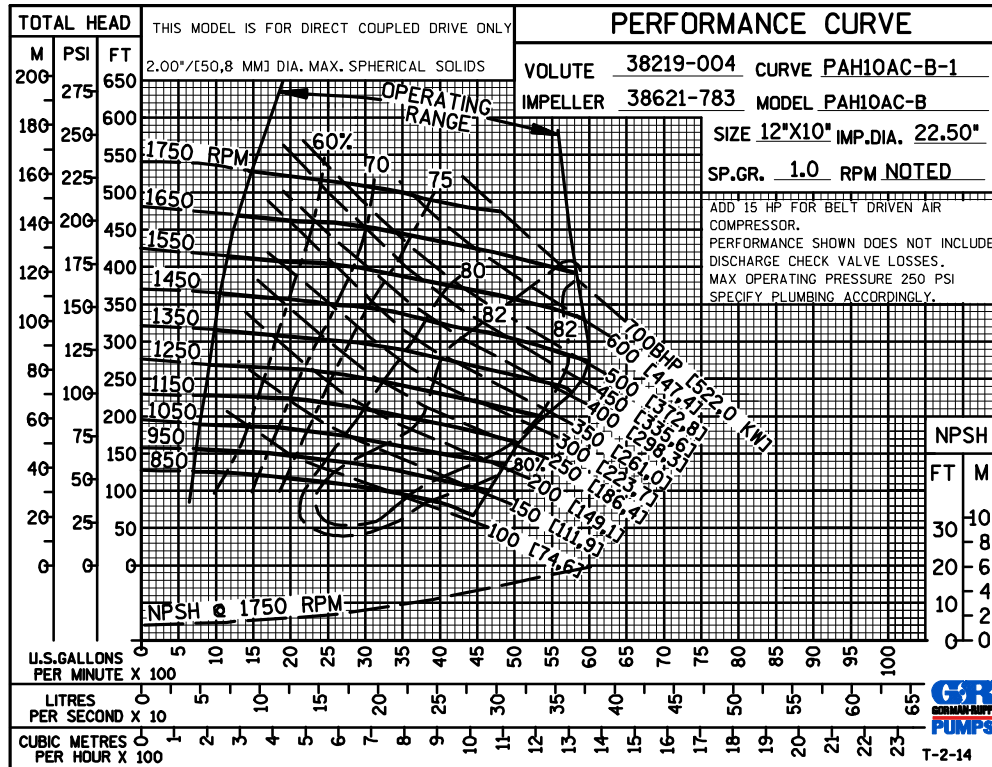

GORMAN-RUPP PUMPS

www.grpumps.com

Specifications Subject to Change Without Notice

Printed in U.S.A.

**60 HERTZ
PERFORMANCE
BASED ON
WATER
TRIMMED
IMPELLER**

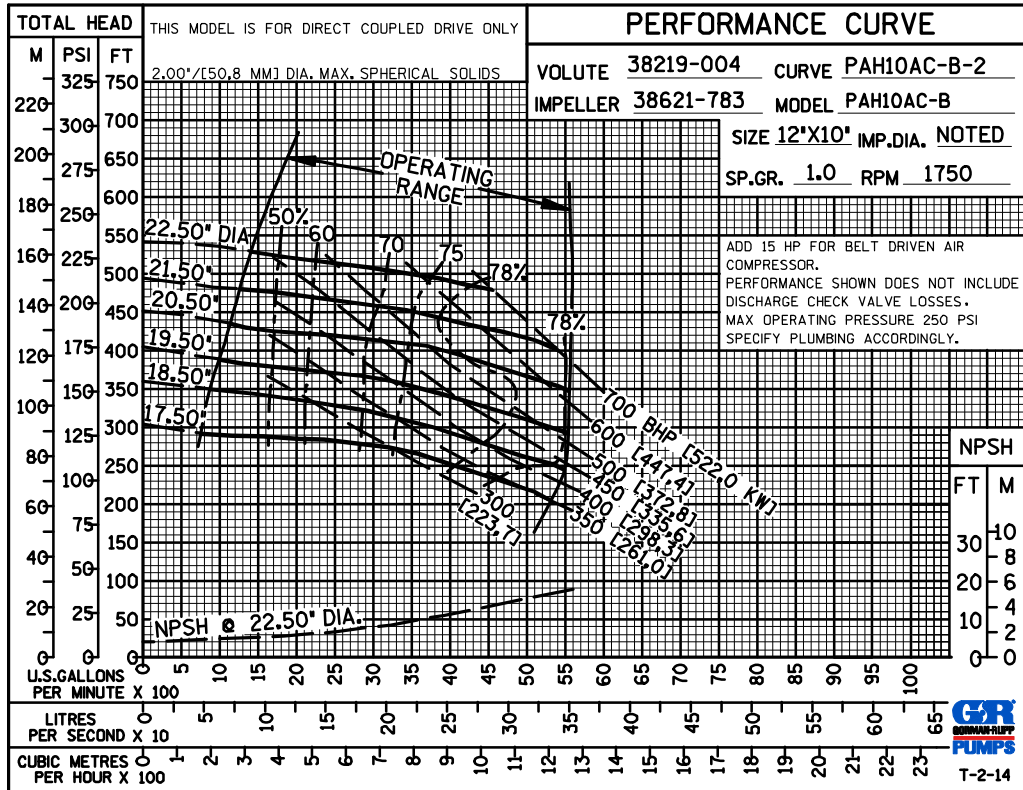

**50 HERTZ
PERFORMANCE
BASED ON
WATER
TRIMMED
IMPELLER**

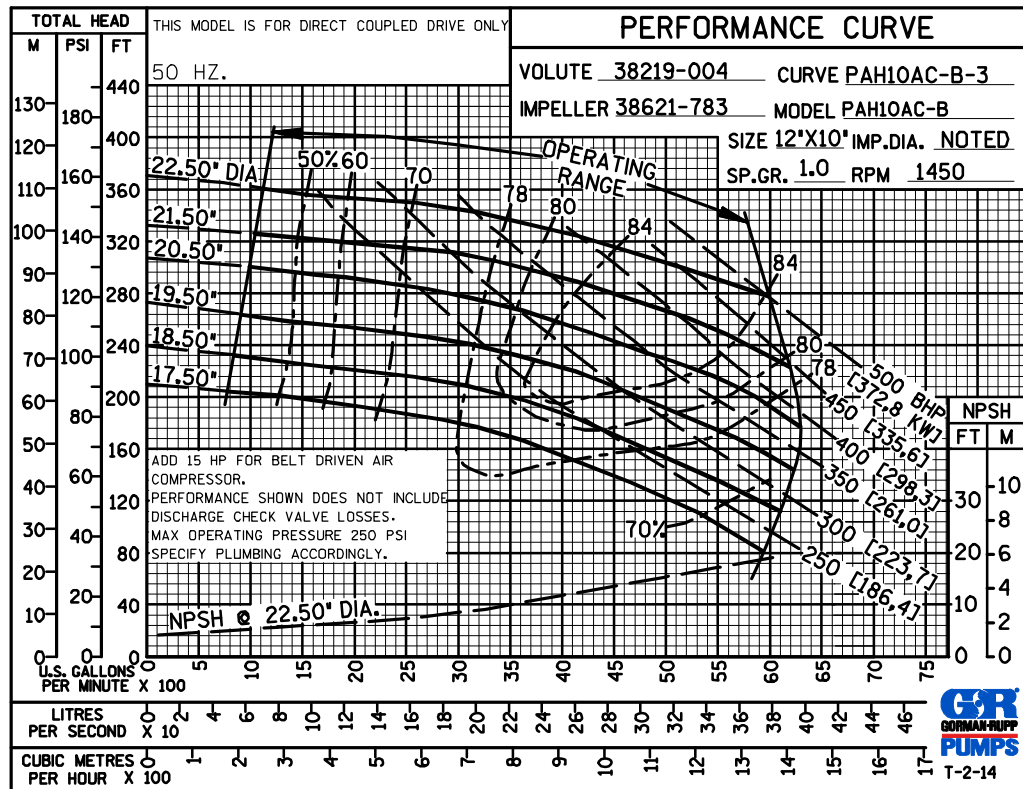

GORMAN-RUPP PUMPS

www.grpumps.com

Specifications Subject to Change Without Notice

Printed in U.S.A.

**60 HERTZ
PERFORMANCE
BASED ON
WATER
TRIMMED
IMPELLER**

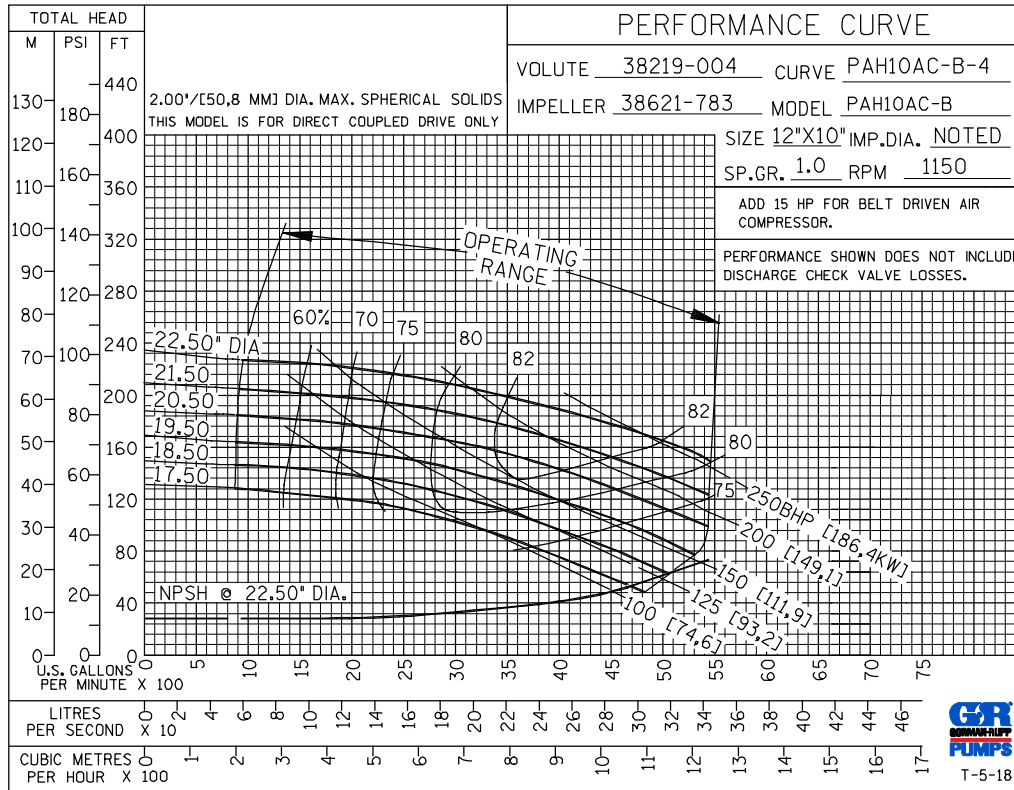

GORMAN-RUPP PUMPS

www.grpumps.com

Specifications Subject to Change Without Notice

Printed in U.S.A.