

Basic Pedestal

Standard Centrifugal Pump



Model VGH1 1/4C31-B

Size 2" x 1 1/4"

PUMP SPECIFICATIONS

Size: 2" x 1 1/4" (51 mm x 32 mm) Raised Face Flanges.

Casing: Ductile Iron.

Maximum Operating Pressure 176 psi (1214 kPa).*

Enclosed Type, Six Vane Impeller: Gray Iron 40.

Handles 11/64" (4,5 mm) Diameter Spherical Solids.

Impeller Shaft: Steel 1045.

Two Replaceable Wear Rings: Gray Iron 25.

Seal Plate: Ductile Iron.

Bypass Flush Piping.

Bearing Housing: Gray Iron 25.

Radial Bearing: Open Single Row Ball.

Thrust Bearing: Open Double Row Ball.

Bearing Lubrication: SAE 30 Non-Detergent Oil.

Gaskets: Nitrile Rubber.

Hardware: Standard Plated Steel.

Bearing Housing Level Oiler.

Optional Equipment: Strainer. NPT Suction and Discharge Flanges. Stainless Steel Impeller. Consult Factory for Optional Seals.



*Consult Factory for Applications Exceeding Maximum Pressure and/or Temperature Indicated.

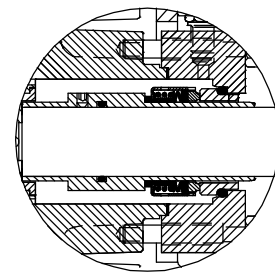
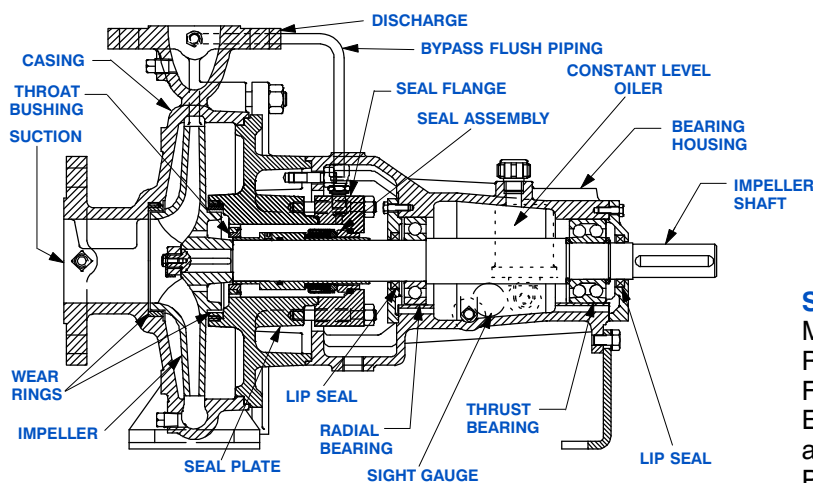

SEAL DETAIL

Mechanical, Self-Lubricated. Silicon Carbide Rotating and Stationary Faces. Fluorocarbon Elastomers (DuPont Viton® or Equivalent). Stainless Steel 316 Shaft Sleeve and Spring. Maximum Temperature of Liquid Pumped, 160°F (71°C).*



GORMAN-RUPP PUMPS

www.grpumps.com

Specifications Subject to Change Without Notice

Printed in U.S.A.

Specification Data

NET WEIGHT: 95 LBS. (43 KG.)
SHIPPING WEIGHT: 105 LBS. (48 KG.)
EXPORT CRATE SIZE: 8.5 CU. FT. (0,24 CU. M.)

SECTION 70, PAGE 126

APPROXIMATE DIMENSIONS and WEIGHTS

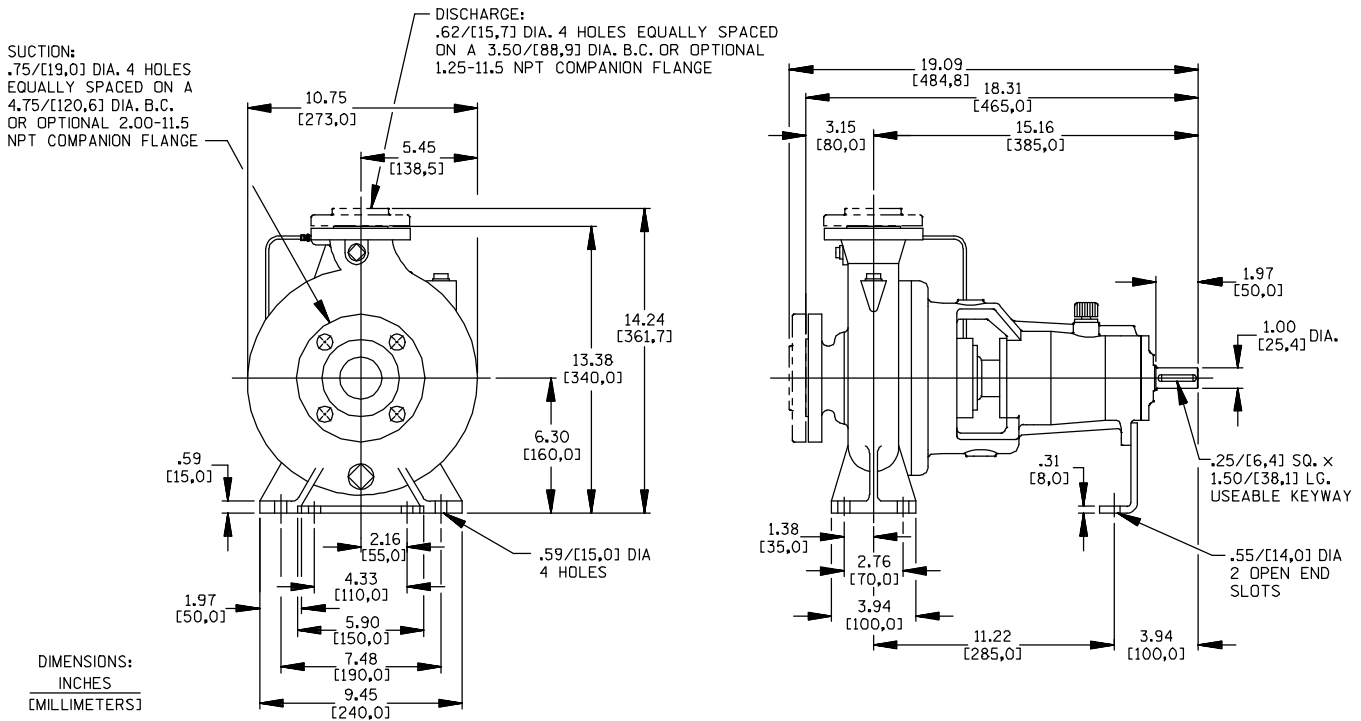

**PERFORMANCE
BASED ON
WATER**

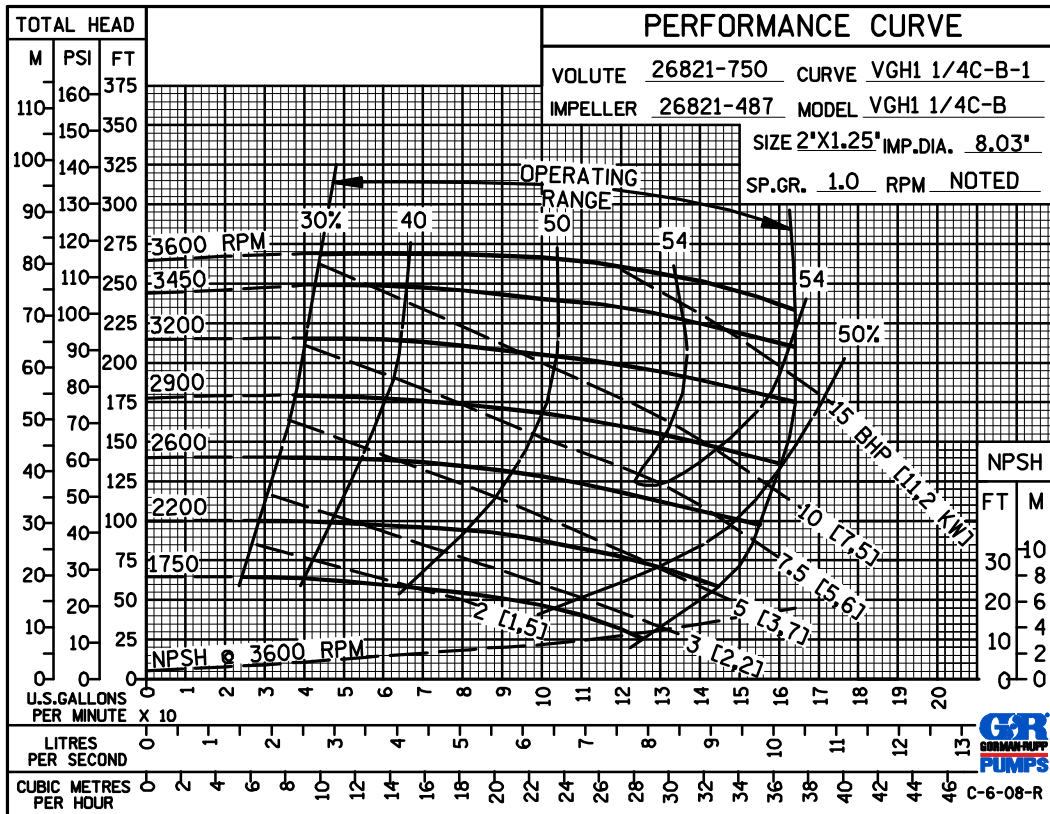

GORMAN-RUPP PUMPS

www.grpumps.com

Specifications Subject to Change Without Notice

Printed in U.S.A.

PERFORMANCE
BASED ON
WATER

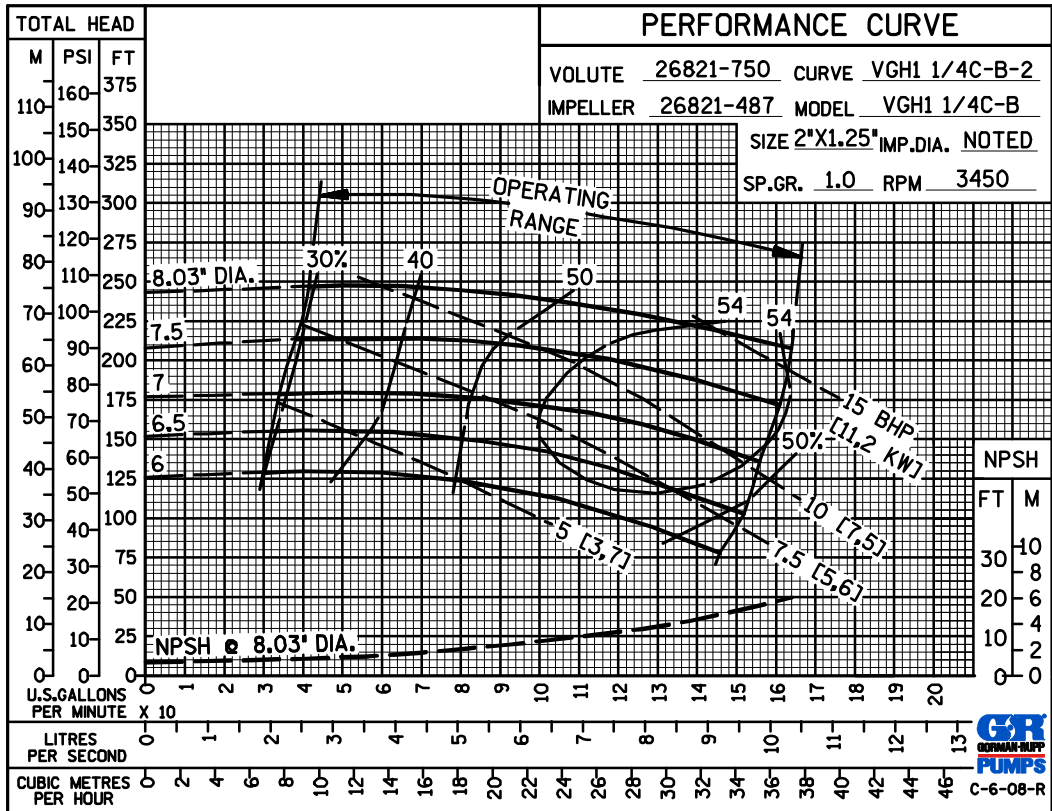

PERFORMANCE
BASED ON
WATER

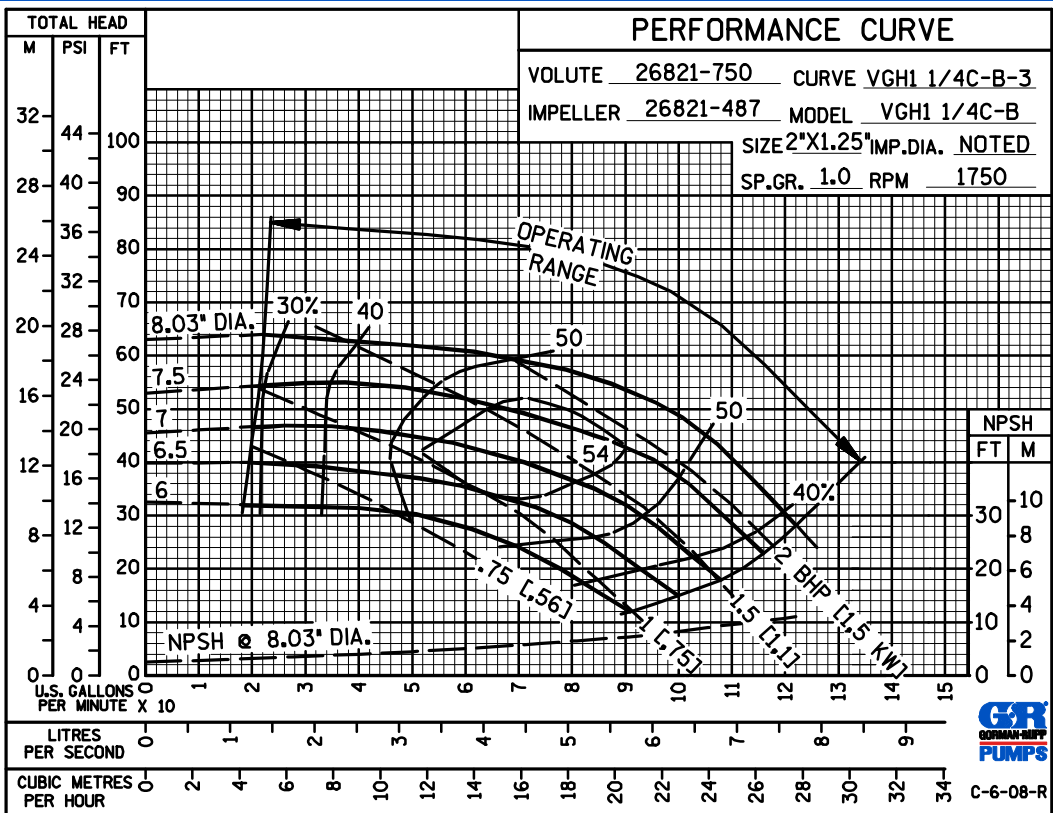

GORMAN-RUPP PUMPS

www.grpumps.com

Specifications Subject to Change Without Notice

Printed in U.S.A.

PERFORMANCE
BASED ON
PETROLEUM

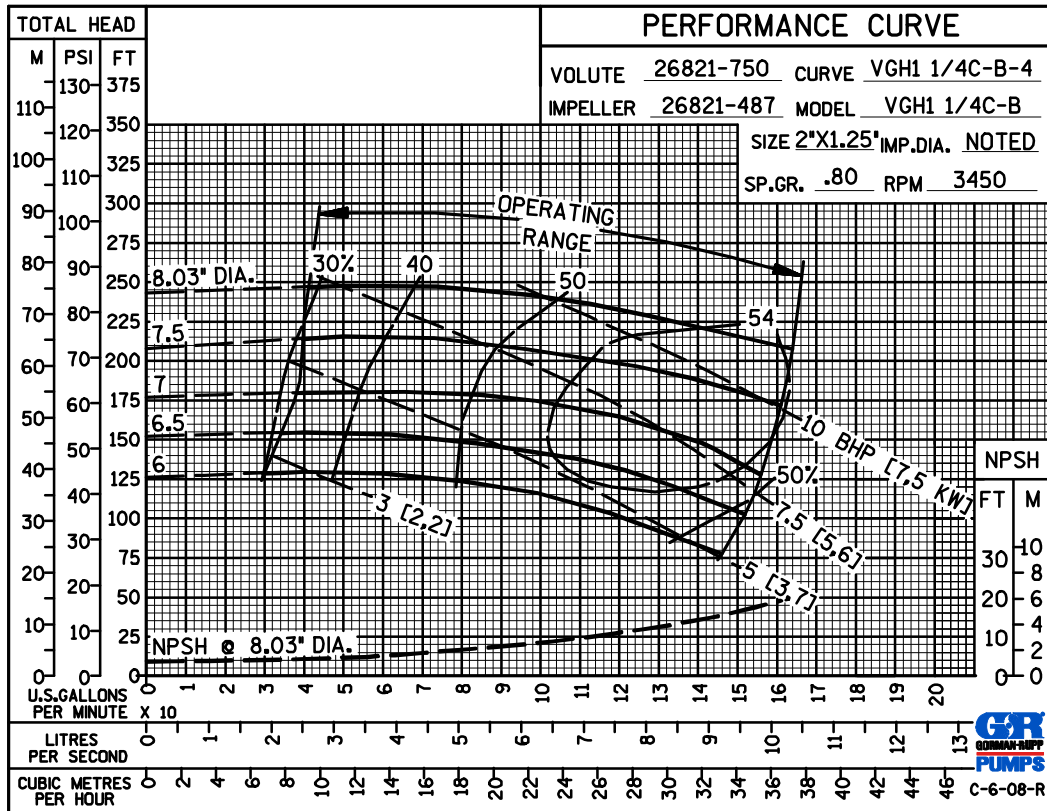

PERFORMANCE
BASED ON
PETROLEUM

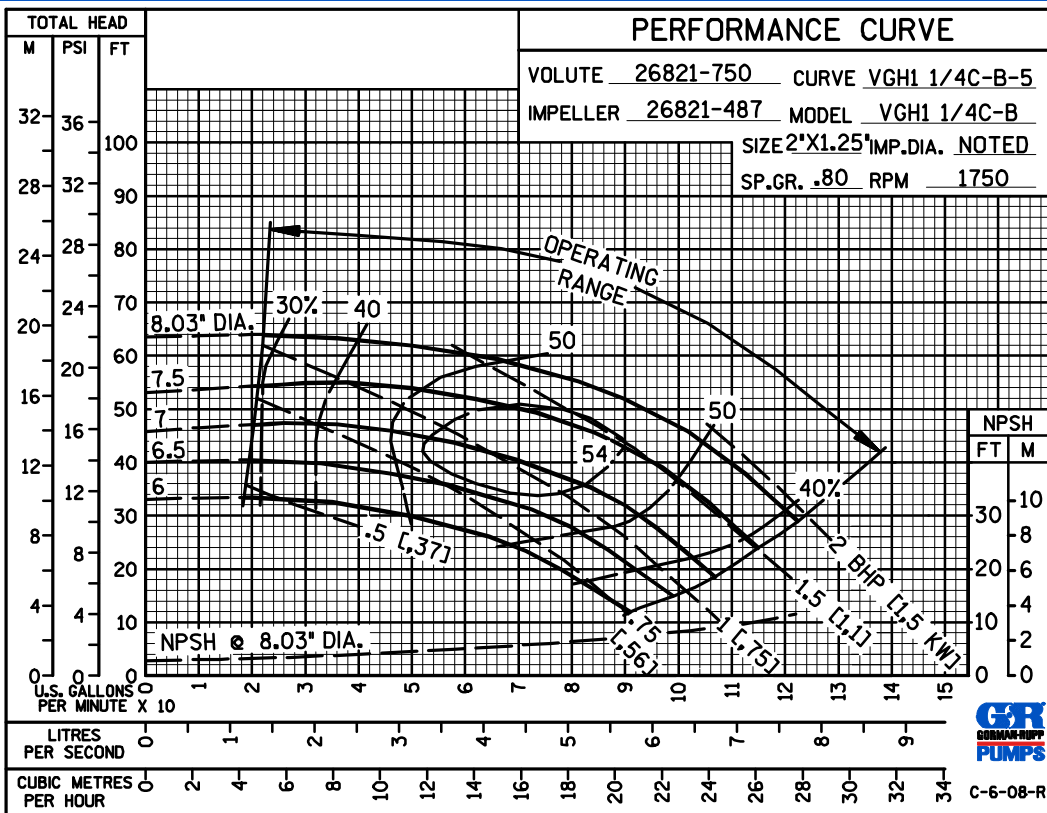

GORMAN-RUPP PUMPS

www.grpumps.com

Specifications Subject to Change Without Notice

Printed in U.S.A.