

10" PE Threaded-Vented fill cap w/ 7" access

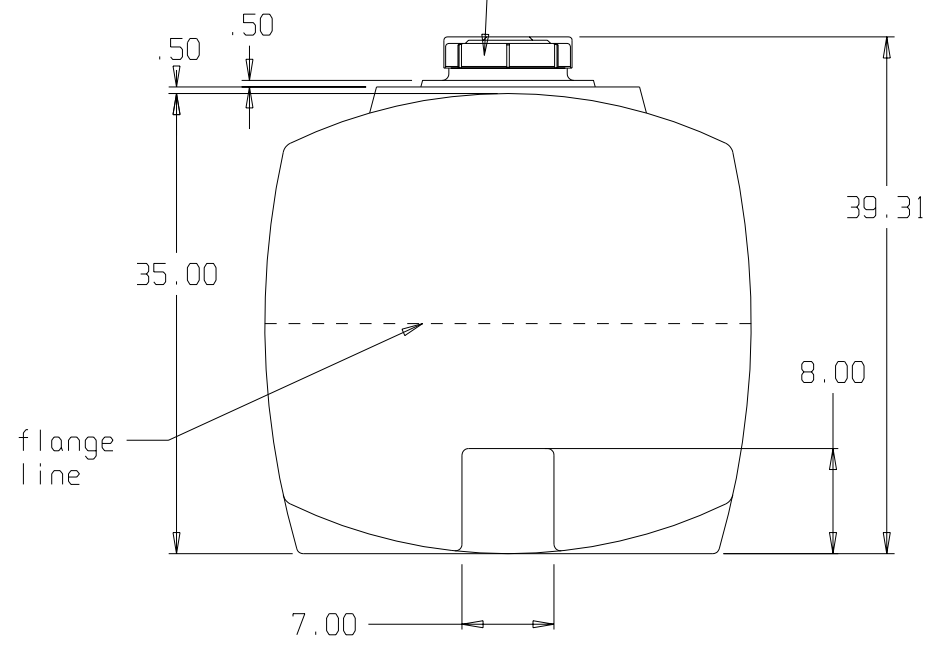
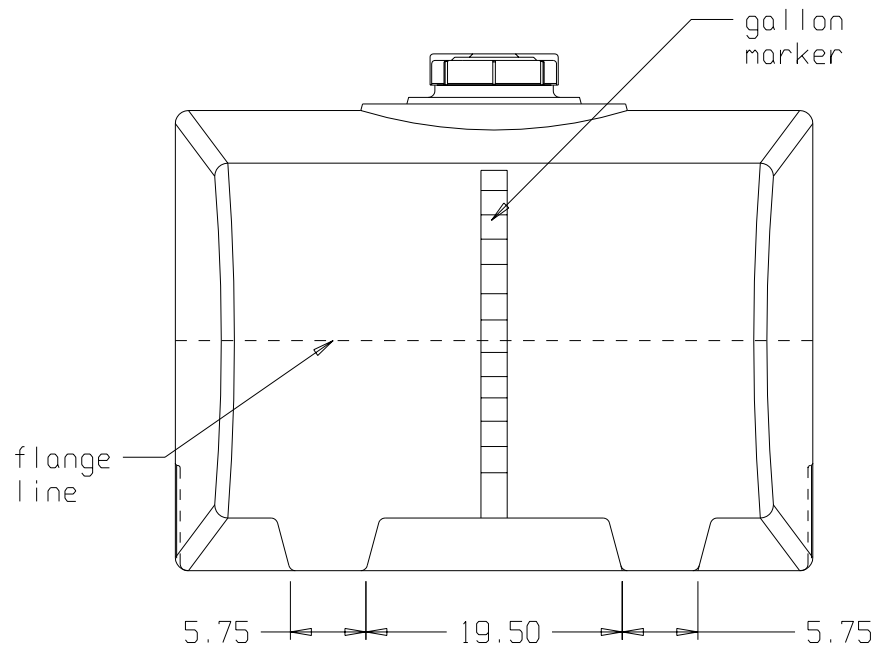

(all dimensions in inches)

BASE FITTINGS TO BE LEFT INSTALLED AT TIME OF SHIPMENT PER SII PROCEDURE

PART # TANK: 166--

200 GALLON RECTANGULAR (PCO) TANK

REF#: 0000

11/20/02