



## Engineered Systems

PART OF OPW FLUID TRANSFER GROUP

A **DOVER** COMPANY



### SWIVEL JOINTS

OPW Engineered Systems, part of the OPW Fluid Transfer Group, provides expert solutions for the safe handling, transfer, monitoring, measuring and protection of hazardous bulk products worldwide.



OPW Engineered Systems specializes in the engineering, designing and manufacturing of systems for the safe and efficient loading and unloading of critical hazardous materials: loading systems, swivel joints, instrumentation, quick and dry disconnect systems and safety breakaways.

## TABLE OF CONTENTS

<b>DESIGN FEATURES</b> . . . . .	<b>4</b>	<b>COUNTERBALANCE SWIVEL JOINTS</b> . . . . .	<b>13</b>
<b>PRESSURE/TEMPERATURE CHART</b> . . . . .	<b>5</b>	STYLE 56 . . . . .	<b>13</b>
<b>STYLES AVAILABLE CHART</b> . . . . .	<b>6</b>	STYLE 58 . . . . .	<b>14</b>
<b>STANDARD SWIVEL JOINTS</b> . . . . .		STYLE 76 . . . . .	<b>14</b>
STYLE 10 . . . . .	<b>12</b>	STYLE 78 . . . . .	<b>14</b>
STYLE 20 . . . . .	<b>7</b>	<b>SPECIALTY SWIVEL JOINTS</b> . . . . .	<b>15</b>
STYLE 30 . . . . .	<b>7</b>	HOSE REEL/VICTAULIC® SWIVELS . . . . .	<b>15</b>
STYLE 34 . . . . .	<b>8</b>	JACKETED SWIVEL JOINTS . . . . .	<b>15</b>
STYLE 35 . . . . .	<b>8</b>	ENDURA™ DUAL SPLIT FLANGE SWIVELS . . . . .	<b>16-17</b>
STYLE 40 . . . . .	<b>8-9</b>	<b>REPAIR PARTS AND PROCEDURES</b> . . . . .	<b>19</b>
STYLE 44 . . . . .	<b>9</b>	<b>DIMENSIONS CHART</b> . . . . .	<b>20</b>
STYLE 45 . . . . .	<b>9</b>	<b>APPROXIMATE WEIGHTS/SPECIFICATIONS</b> . . . . .	<b>21</b>
STYLE 50 . . . . .	<b>10</b>	<b>ORDERING CHART</b> . . . . .	<b>23</b>
STYLE 55 . . . . .	<b>10</b>		
STYLE 60 . . . . .	<b>11</b>		
STYLE 70 . . . . .	<b>11</b>		
STYLE 80 . . . . .	<b>12</b>		

Autolok, Drylok, Twin-Kam, Endura, GFL, Cliplok and Spring Ring are trademarks, and OPW®, Visi-Flo®, Kamvalok® and Kamlok® are registered trademarks of OPW Engineered Systems. Hastelloy® is a registered trademark owned by Haynes International, Inc. Viton® and Kalrez® are registered trademarks of DuPont Dow Elastomers. Teflon® is a registered trademark of DuPont. Chemraz® is a registered trademark of Green Tweed. Scully® and BICLOPS® are registered trademarks of Scully Signal Co.





## OVERVIEW

**OPW Engineered Systems** manufactures swivel joints for a broad range of uses in the chemical, petroleum, petrochemical, refining, mining, distilling, brewing, ink and paint industries, as well as farm irrigation and fertilizing. Design, plant and maintenance engineers use OPW swivels in flexible piping systems, loading arms, hose reels, sewer rodding and wastewater treatment equipment, and various types of process machinery. They also use our swivel joints in machine tool coolant transfer, drum filling applications, and in a variety of in-plant fluid and dry bulk transfer applications.

Versatility is the key to OPW Engineered Systems swivel joints. They make it possible for you to use rigid metal piping for loading and unloading fluids and dry product under pressure or vacuum without the difficulty or danger of handling heavy, cumbersome hoses.

### Proven Experience

For more than 60 years, OPW Engineered Systems has provided innovative solutions for some of the most challenging liquid handling applications. We take pride in our ability to custom design and manufacture swivel joints for specialized applications. Our engineers will work with you to determine the right swivel joint for your application.

### Innovative Products Designed for Safety

Our design efforts are supported by a state-of-the-art CAD system for faster, more accurate responses to your technical requests. OPW swivel joints are durable, reliable, easy to operate and maintain. Available in stainless steel, cast steel, fabricated steel, ductile iron, aluminum and bronze, we meet your most demanding specifications. Our special capabilities include split flange, jacketed, lined and coated.

### Quality Control for Dependable Operation

Our manufacturing and testing procedures meet or exceed industry standards. All swivel joints are rigorously tested to ensure high quality. CNC equipment is used to machine all critical dimensions within precise tolerances to ensure that each product meets our rigid engineering specifications. As with every other part of our product, welding is an important quality factor. Our welders are certified to ASME Boiler and Pressure Vessel Code, Section IX. Particularly important is our 100% weld penetration of fabricated steel and stainless steel swivels to meet code.

Additional testing, including radiography as well as material certifications, can be provided to meet your specific requirements. Special exterior surface preparation and painting is also available.

### Rely on OPW Service and Support

Our sales representatives are knowledgeable about our products and skilled in coordinating the steps involved in solving your problems. This personalized professional service ensures your satisfaction. Support personnel are also available to assist you in evaluation to determine which swivel design is best suited for your application.

**OPW continually strives to maintain our leadership position in the industry by responding to your needs and supplying the high-quality, dependable products you require.**



## DESIGN FEATURES

OPW Engineered Systems fabricated and cast ball bearing swivel joints allow you to construct a metal piping system that permits easy movement in any direction. Moveable, flexible and reliable, OPW Engineered Systems swivels are designed and built to the highest quality standards, including precision machining and 100% penetration welding, with special design features that include:

### 1) Tight Seals

- O-Rings provide a tight seal without hindering swivel action
- Accurately machined and micro-finished grooves provide for minimal seal wear
- Available in Buna-N, Viton®, EPT, Neoprene, Kalrez® and other seal materials as required
- Teflon® seals are available as spring energized or silicone/Viton® encapsulated

### 2) True Ball Bearing Race Alignment

- Body and tail sections are locked together by a double row of ball bearings
- Raceways are machined to precise tolerances
- Double raceway design assures proper alignment and prevents binding caused by temperature changes and heavy radial loads
- Carbon steel swivels have hardened races to maximize load-carrying capability

### 3) Protected Bearing Chamber

- Protective inner O-ring seal prevents product from entering bearing chamber
- Outer seal keeps rain, dirt, and other contaminants out
- Both seals hold in lubrication

### 4) Long-Life Bearings

- Ball bearings are hardened, precision-ground steel
- Stainless steel swivels have stainless steel bearings
- All OPW swivels are available with stainless steel bearings on special order

### 5) Easy Lubrication

- All OPW swivels are pre-lubricated at the factory
- All 3/4", 1", and submerged swivels are permanently lubricated
- A grease fitting between races that accepts a standard grease gun is available for swivels that require field lubrication
- Non-lubricating swivels are available on special order

### 6) No Field Adjustment Necessary

- Balls are held in place by factory-installed plugs that never need to be adjusted to maintain bearing performance

### Convenience of Choice

- Available in a variety of sizes beginning at 3/4" and up
- Available in threaded, flanged, and butt welded ends
- Steam jacketed and split flange swivels are also available

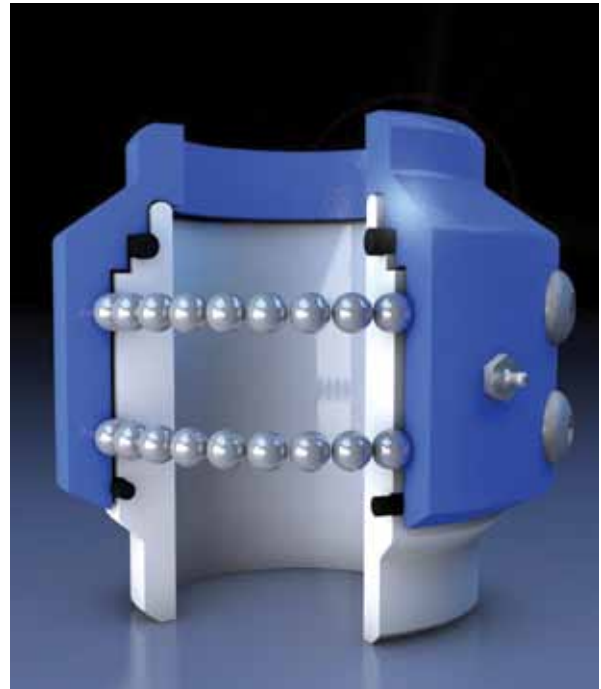

Fabricated Steel and Stainless Steel

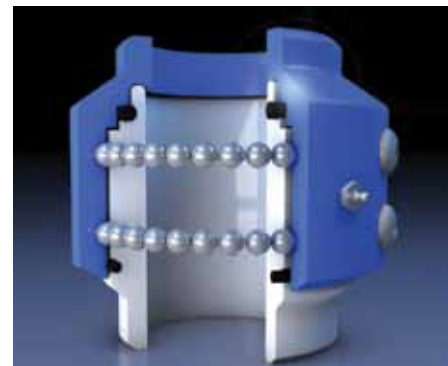

Cast High-Pressure Steel (Main Seal has Teflon® Back-up Ring)



Cast Stainless Steel, Aluminum, Ductile Iron, Bronze

**IMPORTANT:** OPW products should be used in compliance with applicable federal, state, provincial, and local laws and regulations. Product selection should be based on physical specifications and limitations and compatibility with the environment and materials to be handled. OPW MAKES NO WARRANTY OF FITNESS FOR A PARTICULAR USE. All illustrations and specifications in this literature are based on the latest product information available at the time of publication. OPW reserves the right to make changes at any time in prices, materials, specifications and models and to discontinue models without notice or obligation.

# PRESSURE/TEMPERATURE GUIDE

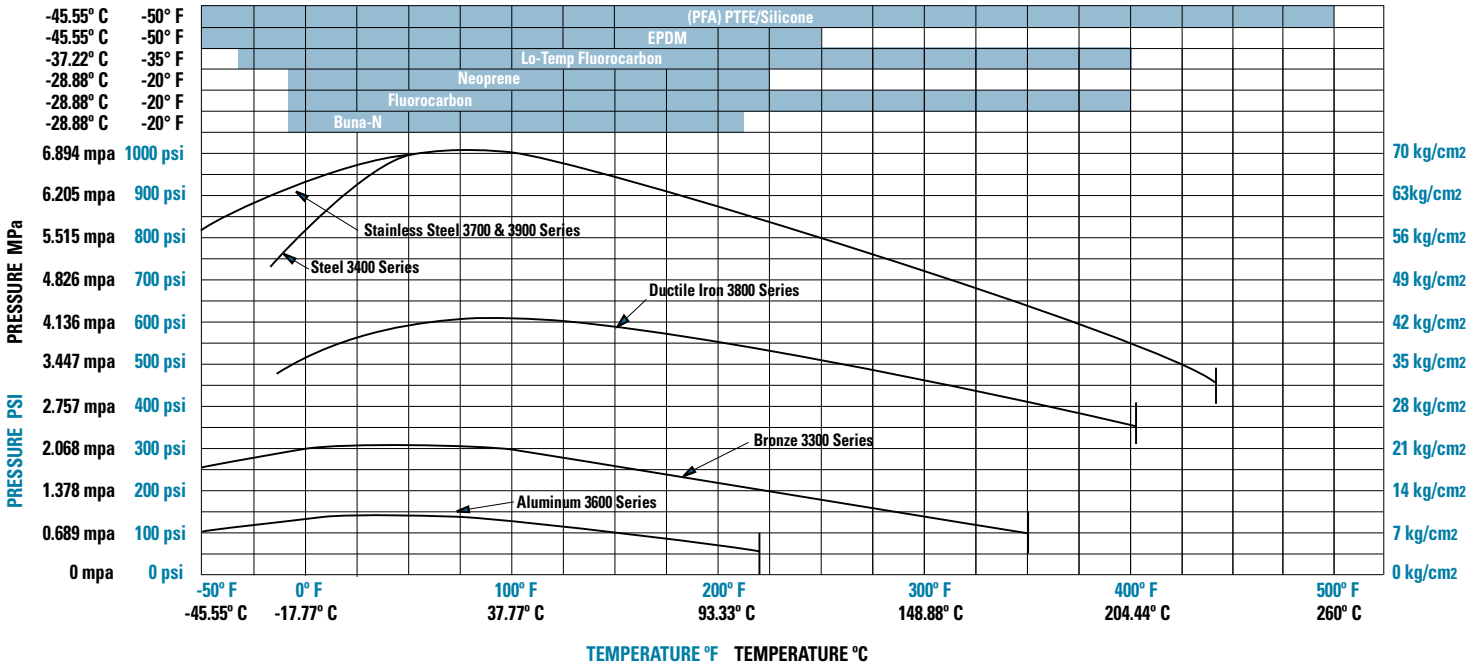

## Availability by Material, Size and Pressure Rating

Material	3/4"	1"	1-1/4"	1-1/2"	2"	3"	4"	6"	8"	10"	12"	Pressure Rating*
	20mm	25mm	32mm	40mm	50mm	80mm	100mm	150mm	200mm	250mm	300mm	
Steel, Cast, High-Pressure 3200 Series		■	■	■								3000 psi 210 kg/cm <sup>2</sup> 20.68 mpa
Steel, Fabricated 3400 Series					■	■	■	■	■	■	■	1000 psi 70 kg/cm <sup>2</sup> 6.89 mpa 8", 10" & 12" 500 psi max
316 Stainless Steel 3700 & 3900 Series	■	■		■	■	■	■	■	■	■	■	1000 psi 70 kg/cm <sup>2</sup> 6.89 mpa 8", 10" & 12" 500 psi max
Aluminum 3600 Series		■		■	■	■	■	■				125 psi 9 kg/cm <sup>2</sup> 0.86 mpa
Ductile Iron 3800 Series		■		■	■	■	■					600 psi 42 kg/cm <sup>2</sup> 4.13 mpa
Bronze 3300 Series		■		■	■	■						300 psi 21 kg/cm <sup>2</sup> 2.06 mpa

\*Maximum pressure rating of OPW swivel joints is as shown, or is determined by the flange/end connection rating, whichever is lower. Buna-N seals are standard in all of the above swivel joints, but each is available with seals made of Viton®, Teflon®, EPT, or Neoprene, depending on the pressures and temperatures of your operation.

# STYLES AVAILABLE

OPW Engineered Systems swivel joints are available in one, two and three planes of rotation for virtually unlimited flexibility. Standard combinations of five different metals and seal materials cover pressures, temperatures, and corrosion resistance and load bearing capacities well within the limits of most application requirements.



OPW swivel joints are available in two types of body construction – cast and fabricated – which differ in appearance. For illustrative purposes only, most of the drawings featured on the following pages are the “fabricated type”.



Rotary manifold board uses OPW Engineered Systems swivel joints and dry disconnect fittings to clean up messy hose exchange areas in blending and similar operations.

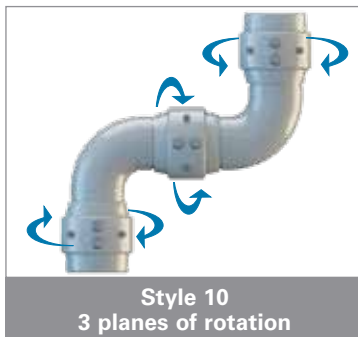

Style 10  
3 planes of rotation



Style 20  
1 plane of rotation



Style 30  
1 plane of rotation

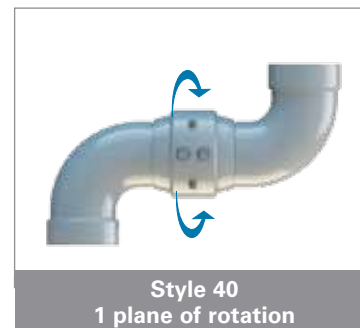

Style 40  
1 plane of rotation

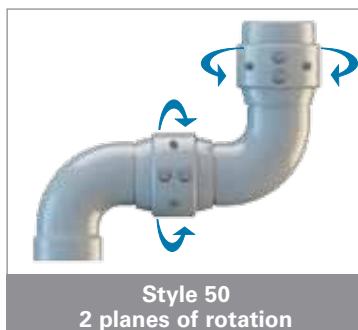

Style 50  
2 planes of rotation



Style 60  
2 planes of rotation

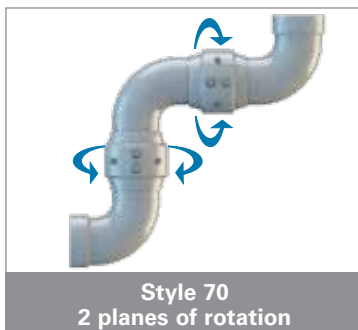

Style 70  
2 planes of rotation

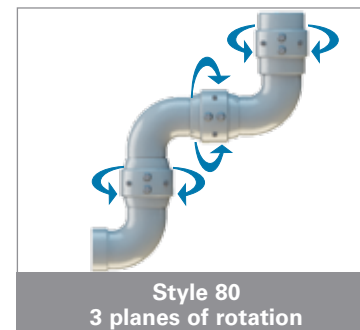

Style 80  
3 planes of rotation

**NOTE:** Flanged or butt weld ends are available in many styles and sizes. Only the most common styles of OPW swivel joints appear on the following pages. If you don't see exactly what you need, please contact us.

## STYLE 20

### Thread x Thread Style 20

Material	Model	Size (inches)	Dimensions
Steel, Cast, High Pressure	3220	1, 1-1/4, 1-1/2, 2	▲
Steel, Fabricated	3420	2, 3, 4	▲
Stainless Steel, Cast	3720	3/4, 1, 1-1/2	▲
Stainless Steel, Fabricated	3920	2, 3, 4	▲
Aluminum	3620	1, 1-1/2, 2, 3, 4	●
Ductile Iron	3820	1, 1-1/2, 2, 3, 4	●
Bronze	3320	1, 1-1/2, 2, 3	●

### Flange x Flange Style 20F

Material	Model	Size (inches)	Dimensions
Steel, Fabricated	3420F	2, 3, 4, 6, 8, 10	▲
Stainless Steel, Fabricated	3920F	2, 3, 4, 6, 8, 10	▲
Aluminum	3620F	3, 4, 6	●

### Butt Weld x Butt Weld Style 20W

Material	Model	Size (inches)	Dimensions
Steel, Fabricated	3420W	2, 3, 4, 6, 8, 10	▲
Stainless Steel, Fabricated	3920W	2, 3, 4, 6, 8, 10	▲

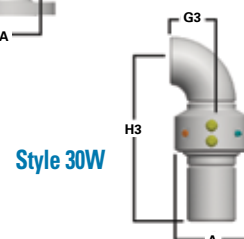
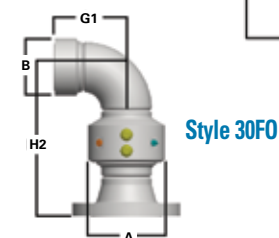
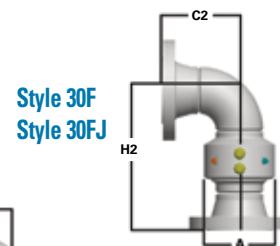
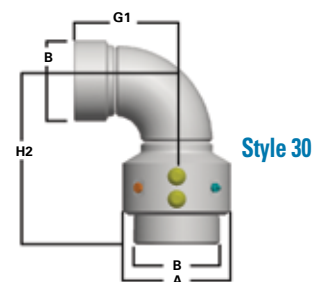
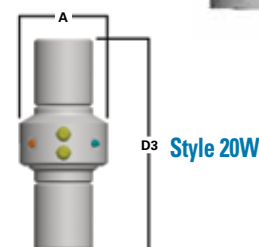
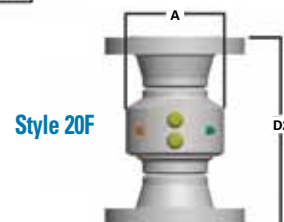
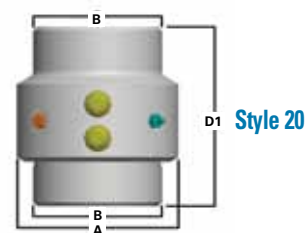

## STYLE 30

### Thread x Thread Style 30

Material	Model	Size (inches)	Dimensions
Steel, Cast, High Pressure	3230	1, 1-1/4, 1-1/2, 2	▲
Steel, Fabricated	3430	2, 3, 4	▲
Stainless Steel, Cast	3730	3/4, 1, 1-1/2	▲
Stainless Steel, Fabricated	3930	2, 3, 4	▲
Aluminum	3630	1, 1-1/2, 2, 3, 4	●
Ductile Iron	3830	1, 1-1/2, 2, 3, 4	●
Bronze	3330	1, 1-1/2, 2, 3	●

### Flange x Flange Style 30F

Material	Model	Size (inches)	Dimensions
Steel, Fabricated	3430F	2, 3, 4, 6, 8, 10	▲
Stainless Steel, Fabricated	3930F	2, 3, 4, 6, 8, 10	▲
Aluminum	3630F	3, 4, 6	●
Ductile Iron	3830F	3, 4	●

### Flange for Submerged Use Style 30FJ

Material	Model	Size (inches)	Dimensions
Steel, Fabricated	3430FJ	2, 3, 4, 6, 8, 10	▲
Stainless Steel, Fabricated	3930FJ	2, 3, 4, 6, 8, 10	▲
Aluminum	3630FJ	3, 4, 6	●

### Flange x Thread Style 30FO

Material	Model	Size (inches)	Dimensions
Steel, Fabricated	3430FO	2, 3, 4	▲
Stainless Steel, Fabricated	3930FO	2, 3, 4	▲
Aluminum	3630FO	3, 4	●
Ductile Iron	3830FO	3, 4	●

### Butt Weld x Butt Weld Style 30W

Material	Model	Size (inches)	Dimensions
Steel, Fabricated	3430W	2, 3, 4, 6, 8, 10	▲
Stainless Steel, Fabricated	3930W	2, 3, 4, 6, 8, 10	▲

Dimensions Chart on page 20: ▲ Steel & Stainless Steel ● Aluminum, Ductile Iron & Bronze

## STYLE 34

Thread x Thread Style 34	Material	Model	Size (inches)	Dimensions
	Steel, Fabricated	3434	2, 3, 4	▲
	Stainless Steel, Fabricated	3934	2, 3, 4	▲

Flange x Flange Style 34F	Material	Model	Size (inches)	Dimensions
	Steel, Fabricated	3434F	2, 3, 4	▲
	Stainless Steel, Fabricated	3934F	2, 3, 4	▲

## STYLE 35

Thread x Thread Style 35	Material	Model	Size (inches)	Dimensions
	Steel, Fabricated	3435	2, 3, 4	▲
	Stainless Steel, Fabricated	3935	2, 3, 4	▲
	Aluminum	3635	3, 4	●

Flange x Flange Style 35F	Material	Model	Size (inches)	Dimensions
	Steel, Fabricated	3435F	2, 3, 4, 6	▲
	Stainless Steel, Fabricated	3935F	2, 3, 4, 6	▲

TTMA Truck Flanges Style 35F T	Material	Model	Size (inches)	Dimensions
	Aluminum	3635FT	4	●
	Aluminum	3635FTH*	4	●

\*Comes complete with straight pipe handle.

## STYLE 40

Thread x Thread Style 40	Material	Model	Size (inches)	Dimensions
	Steel, Cast, High Pressure	3240	1, 1-1/4, 1-1/2, 2	▲
	Steel, Fabricated	3440	2, 3, 4	▲
	Stainless Steel, Cast	3740	3/4, 1, 1-1/2	▲
	Stainless Steel, Fabricated	3940	2, 3, 4	▲
	Aluminum	3640	1, 1-1/2, 2, 3, 4	●
	Ductile Iron	3840	1, 1-1/2, 2, 3, 4	●
	Bronze	3340	1, 1-1/2, 2, 3	●

Flange x Flange Style 40F	Material	Model	Size (inches)	Dimensions
	Steel, Fabricated	3440F	2, 3, 4, 6, 8, 10	▲
	Stainless Steel, Fabricated	3940F	2, 3, 4, 6, 8, 10	▲
	Aluminum	3640F	3, 4, 6	●
	Ductile Iron	3840F	3, 4	●

Flanged for Submerged Use Style 40FJ	Material	Model	Size (inches)	Dimensions
	Steel, Fabricated	3440FJ	2, 3, 4, 6, 8, 10	▲
	Stainless Steel, Fabricated	3940FJ	2, 3, 4, 6, 8, 10	▲
	Aluminum	3640FJ	2, 3, 4, 6	●

Flange x Thread Style 40FO	Material	Model	Size (inches)	Dimensions
	Steel, Fabricated	3440FO	2, 3, 4	▲
	Stainless Steel, Fabricated	3940FO	2, 3, 4	▲
	Aluminum	3640FO	3, 4	●
	Ductile Iron	3840FO	3, 4	●

Dimensions Chart on page 20: ▲ Steel & Stainless Steel ● Aluminum, Ductile Iron & Bronze

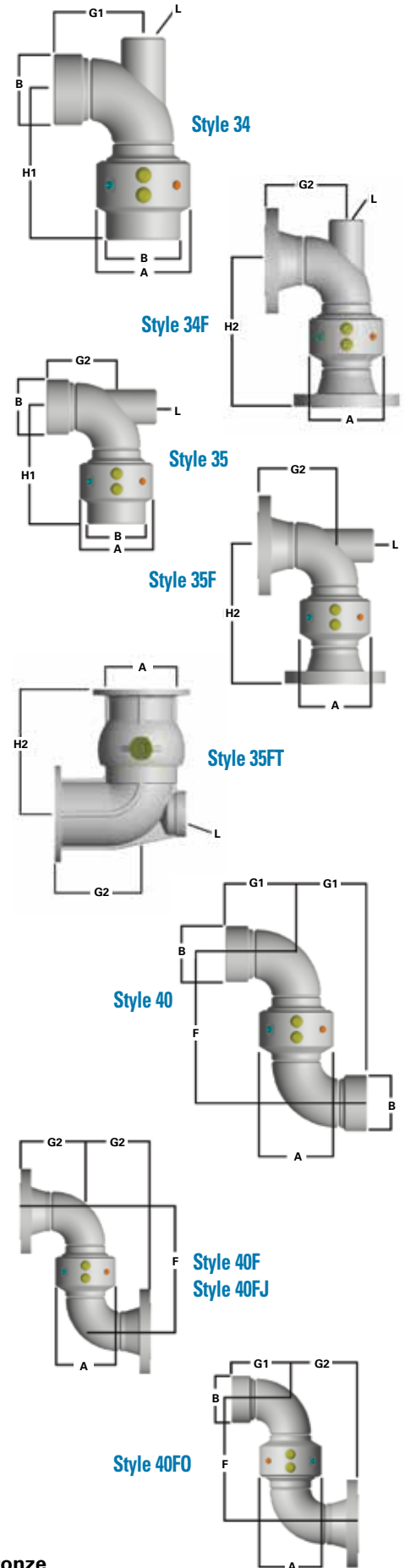



## STYLE 40 (CONTINUED)

TTMA Truck Flange Style 40FT	Material	Model	Size (inches)	Dimensions
	Aluminum	3640FT	3, 4	●
TTMA Truck Flange x Thread Style 40FTO	Material	Model	Size (inches)	Dimensions
	Aluminum	3640FTO	3, 4	●
Butt Weld x Butt Weld Style 40W	Material	Model	Size (inches)	Dimensions
	Steel, Fabricated	3440W	2, 3, 4, 6, 8, 10	▲
	Stainless Steel, Fabricated	3940W	2, 3, 4, 6, 8, 10	▲

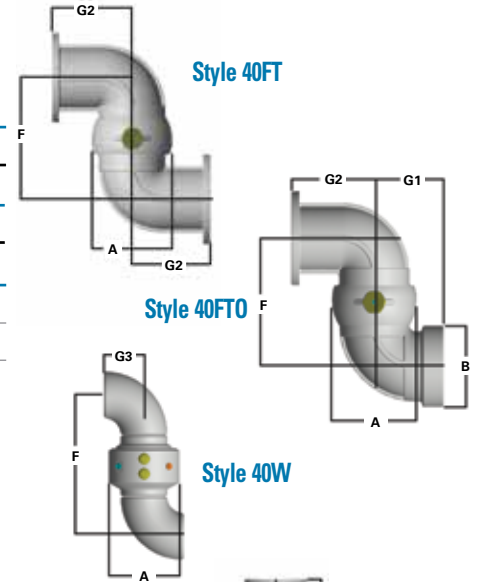

## STYLE 44 (LOADING ARM DROP TUBE SWIVEL WITH GRASP HANDLE)

Thread x Thread Style 44	Material	Model	Size (inches)	Dimensions
	Steel, Fabricated	3444	2, 3, 4	▲
	Stainless Steel, Fabricated	3944	2, 3, 4	▲
	Aluminum	3644	2, 3, 4	●
Flange x Flange Style 44F	Material	Model	Size (inches)	Dimensions
	Steel, Fabricated	3444F	2, 3, 4	▲
	Stainless Steel, Fabricated	3944F	2, 3, 4	▲
	Aluminum	3644F	3, 4, 6	●
Flange x Thread Style 44FO	Material	Model	Size (inches)	Dimensions
	Steel, Fabricated	3444FO	2, 3, 4	▲
	Stainless Steel, Fabricated	3944FO	2, 3, 4	▲
	Aluminum	3644FO	3, 4	●
TTMA Truck Flange Style 44FT	Material	Model	Size (inches)	Dimensions
	Aluminum	3644FT	3, 4	●
TTMA Truck Flange x Thread Style 44FTO	Material	Model	Size (inches)	Dimensions
	Aluminum	3644FTO	3, 4	●

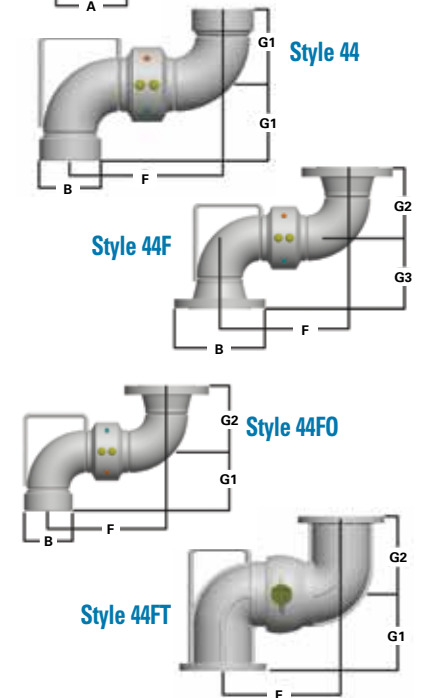

## STYLE 45

Thread x Thread Style 45	Material	Model	Size (inches)	Dimensions
	Steel, Fabricated	3445	2, 3, 4	▲
	Stainless Steel, Fabricated	3945	2, 3, 4	▲
	Aluminum	3645	3, 4	●
Flange x Flange Style 45F	Material	Model	Size (inches)	Dimensions
	Steel, Fabricated	3445F	2, 3, 4, 6	▲
	Stainless Steel, Fabricated	3945F	2, 3, 4, 6	▲

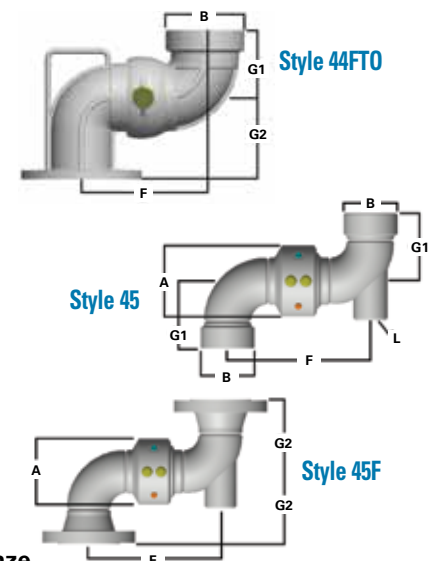

Dimensions Chart on page 20: ▲ Steel & Stainless Steel ● Aluminum, Ductile Iron & Bronze

## STYLE 50

### Thread x Thread Style 50

Material	Model	Size (inches)	Dimensions
Steel Cast, High Pressure	3250	1, 1-1/2, 2	▲
Steel, Fabricated	3450	2, 3, 4	▲
Stainless Steel, Cast	3750	2, 3, 4	▲
Stainless Steel, Fabricated	3950	2, 3, 4	▲
Aluminum	3650	1-1/2, 2, 3, 4	●
Ductile Iron	3850	2, 3, 4	●

### Flange x Flange Style 50F

Material	Model	Size (inches)	Dimensions
Steel, Fabricated	3450F	2, 3, 4, 6, 8, 10	▲
Stainless Steel, Fabricated	3950F	2, 3, 4, 6, 8, 10	▲
Aluminum	3650F	3, 4	●
Ductile Iron	3850F	3, 4	●

### Flange x Thread Style 50FO

Material	Model	Size (inches)	Dimensions
Steel, Fabricated	3450FO	2, 3, 4	▲
Stainless Steel, Fabricated	3950FO	2, 3, 4	▲
Aluminum	3650FO	3, 4	●
Ductile Iron	3850FO	3, 4	●

### TTMA Truck Flange Style 50FT

Material	Model	Size (inches)	Dimensions
Aluminum	3650FT	3, 4	●

### Butt Weld x Butt Weld Style 50W

Material	Model	Size (inches)	Dimensions
Steel, Fabricated	3450W	2, 3, 4, 6, 8, 10	▲
Stainless Steel, Fabricated	3950W	2, 3, 4, 6, 8, 10	▲



Counterweighted loading arms of this type use basic Style 55 inlet swivels. Style 55FO inlet swivel is shown. Aluminum swivels are not recommended for this application.

## STYLE 55

### Thread x Thread Style 55

Material	Model	Size (inches)	Dimensions
Steel, Fabricated	3455	2, 3, 4	▲
Stainless Steel, Fabricated	3955	2, 3, 4	▲
Aluminum	3655	3, 4	●
Ductile Iron	3855	2, 3	●

### Flange x Flange Style 55F

Material	Model	Size (inches)	Dimensions
Steel, Fabricated	3455F	2, 3, 4, 6	▲
Stainless Steel, Fabricated	3955F	2, 3, 4, 6	▲

### Flange x TTMA Truck Flange Style 55FFT

Material	Model	Size (inches)	Dimensions
Steel, Fabricated	3455FFT	3, 4	▲
Ductile Iron	3855FFT	3	●

### Flange x Thread Style 55FO

Material	Model	Size (inches)	Dimensions
Steel, Fabricated	3455FO	2, 3, 4	▲
Stainless Steel, Fabricated	3955FO	2, 3, 4	▲
Aluminum	3655FO	3, 4	●
Ductile Iron	3855FO	3	●

### TTMA Truck Flange Style 55FT

Material	Model	Size (inches)	Dimensions
Aluminum	3655FT	4	●

### Thread x TTMA Truck Flange Style 55TFT

Material	Model	Size (inches)	Dimensions
Ductile Iron	3855TFT	3	●

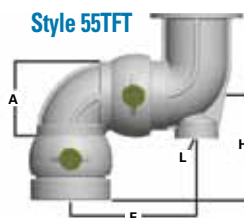
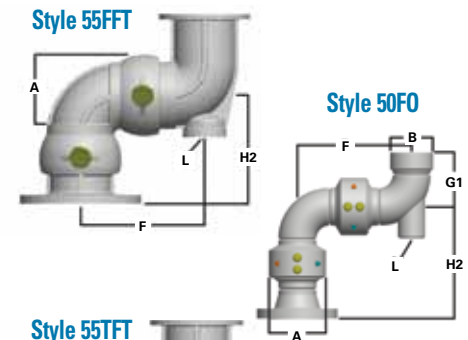
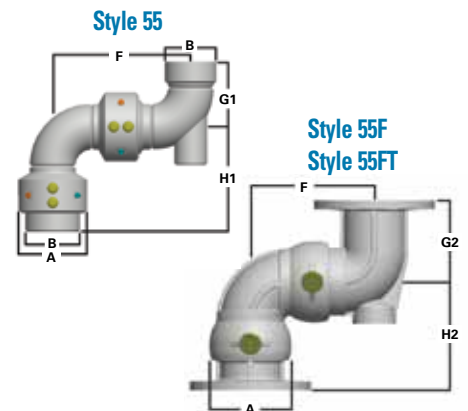
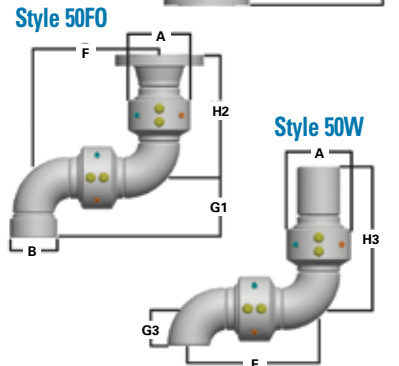
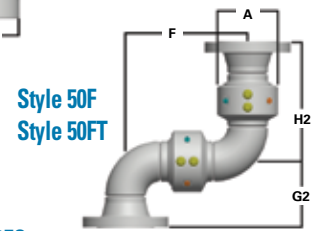
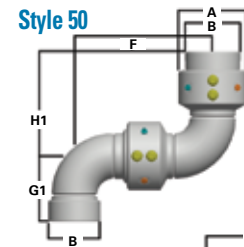

Dimensions Chart on page 20: ▲ Steel & Stainless Steel ● Aluminum, Ductile Iron & Bronze

**IMPORTANT:** OPW products should be used in compliance with applicable federal, state, provincial, and local laws and regulations. Product selection should be based on physical specifications and limitations and compatibility with the environment and materials to be handled. OPW MAKES NO WARRANTY OF FITNESS FOR A PARTICULAR USE. All illustrations and specifications in this literature are based on the latest product information available at the time of publication. OPW reserves the right to make changes at any time in prices, materials, specifications and models and to discontinue models without notice or obligation.

## STYLE 60

### Thread x Thread Style 60

Material	Model	Size (inches)	Dimensions
Steel Cast, High Pressure	3260	1, 1-1/2, 2	▲
Steel, Fabricated	3460	2, 3, 4	▲
Stainless Steel, Cast	3760	1, 1 1/2	▲
Stainless Steel, Fabricated	3960	2, 3, 4	▲
Aluminum	3660	1-1/2, 2, 3, 4	●
Ductile Iron	3860	2, 3, 4	●

### Flange x Flange Style 60F

Material	Model	Size (inches)	Dimensions
Steel, Fabricated	3460F	2, 3, 4, 6, 8, 10	▲
Stainless Steel, Fabricated	3960F	2, 3, 4, 6, 8, 10	▲
Aluminum	3660F	3, 4	●
Ductile Iron	3860F	3, 4	●

### Flange x Thread Style 60FO

Material	Model	Size (inches)	Dimensions
Steel, Fabricated	3460FO	2, 3, 4	▲
Stainless Steel, Fabricated	3960FO	2, 3, 4	▲
Aluminum	3660FO	3, 4	●
Ductile Iron	3860FO	3, 4	●

### Thread x Thread, with Drilled Boss Style 60T

Material	Model	Size (inches)	Dimensions
Ductile Iron	3860T	2	●
Bronze	3360T	1-1/2, 2	●

### Butt Weld x Butt Weld Style 60W

Material	Model	Size (inches)	Dimensions
Steel, Fabricated	3460W	2, 3, 4, 6, 8, 10	▲
Stainless Steel, Fabricated	3960W	2, 3, 4, 6, 8, 10	▲

## STYLE 70

### Thread x Thread Style 70

Material	Model	Size (inches)	Dimensions
Steel, Cast, High Pressure	3270	1, 1-1/2, 2	▲
Steel, Fabricated	3470	2, 3, 4	▲
Stainless Steel, Cast	3770	1, 1-1/2	▲
Stainless Steel, Fabricated	3970	2, 3, 4	▲
Aluminum	3670	1-1/2, 2, 3, 4	▲
Ductile Iron	3870	2, 3, 4	●

### Flange x Flange Style 70F

Material	Model	Size (inches)	Dimensions
Steel, Fabricated	3470F	2, 3, 4, 6, 8, 10	▲
Stainless Steel, Fabricated	3970F	2, 3, 4, 6, 8, 10	▲
Aluminum	3670F	3, 4	●
Ductile Iron	3860F	3, 4	●

### Flange x Thread Style 70FO

Material	Model	Size (inches)	Dimensions
Steel, Fabricated	3470FO	2, 3, 4	▲
Stainless Steel, Fabricated	3970FO	2, 3, 4	▲
Aluminum	3670FO	3, 4	●
Ductile Iron	3870FO	3, 4	●

### TTMA Truck Flange Style 70FT

Material	Model	Size (inches)	Dimensions
Aluminum	3670FT	3, 4	●

### TTMA Truck Flange x Thread Style 70FTO

Material	Model	Size (inches)	Dimensions
Aluminum	3670FTO	3	●

### Butt Weld x Butt Weld Style 70W

Material	Model	Size (inches)	Dimensions
Steel, Fabricated	3470W	2, 3, 4, 6, 8, 10	▲
Stainless Steel, Fabricated	3970W	2, 3, 4, 6, 8, 10	▲

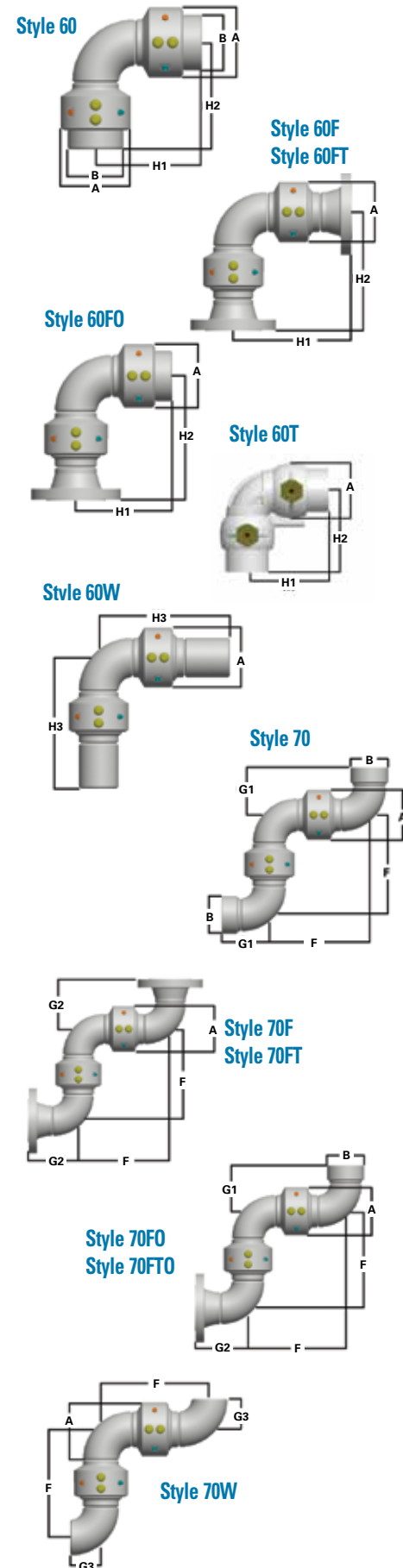

Dimensions Chart on page 20: ▲ Steel & Stainless Steel ● Aluminum, Ductile Iron & Bronze

## STYLE 80\*

### Thread x Thread Style 80

Material	Model	Size (inches)	Dimensions
Steel, Fabricated	3480	2, 3, 4	▲
Stainless Steel, Fabricated	3980	2, 3, 4	▲

### Flange x Flange Style 80F

Material	Model	Size (inches)	Dimensions
Steel, Fabricated	3480F	2, 3, 4, 6, 8, 10	▲
Stainless Steel, Fabricated	3980F	2, 3, 4, 6, 8, 10	▲

\*Flange x thread (Style 80FO) and butt weld x butt weld (Style 80W) units are also available.

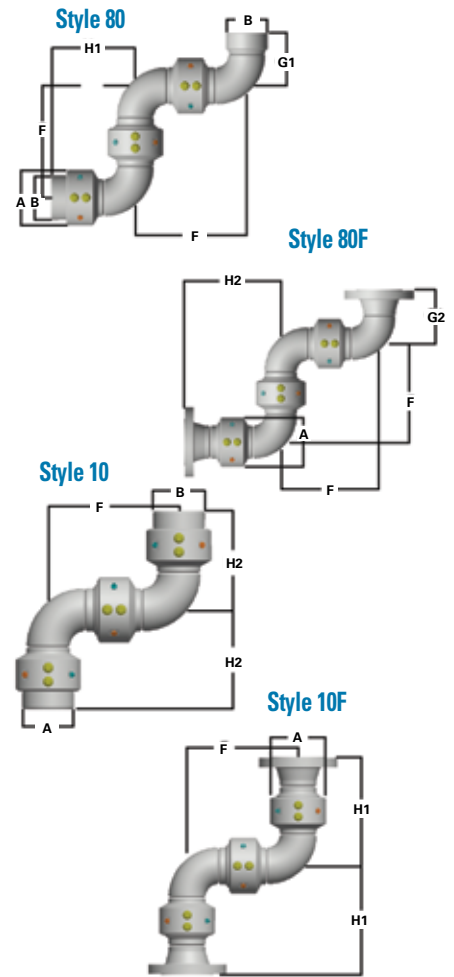

## STYLE 10\*

### Thread x Thread Style 10

Material	Model	Size (inches)	Dimensions
Steel, Fabricated	3410	2, 3, 4	▲
Stainless Steel, Fabricated	3910	2, 3, 4	▲

### Flange x Flange Style 10F

Material	Model	Size (inches)	Dimensions
Steel, Fabricated	3410F	2, 3, 4, 6, 8, 10	▲
Stainless Steel, Fabricated	3910F	2, 3, 4, 6, 8, 10	▲

\*Flange x thread (Style 10FO) and butt weld x butt weld (Style 10W) units are also available.



Swivel joints are an integral part of OPW's complete line of loading arm assemblies. This arm replaced hose in a railcar unloading operation.

Dimensions Chart on page 20: ▲ Steel & Stainless Steel ● Aluminum, Ductile Iron & Bronze

**IMPORTANT:** OPW products should be used in compliance with applicable federal, state, provincial, and local laws and regulations. Product selection should be based on physical specifications and limitations and compatibility with the environment and materials to be handled. OPW MAKES NO WARRANTY OF FITNESS FOR A PARTICULAR USE. All illustrations and specifications in this literature are based on the latest product information available at the time of publication. OPW reserves the right to make changes at any time in prices, materials, specifications and models and to discontinue models without notice or obligation.

## COUNTERBALANCE SWIVELS

OPW Engineered Systems counterbalance swivels for both counterweighted loading arms (see Style 55 on page 10) and torsion spring-balanced loading arms are available (Styles 56, 58, 76, and 78) to cover virtually any combination of riser orientation and swivel offset, including:

- Upfeed right hand
- Upfeed left hand
- Downfeed right hand
- Downfeed left hand

If you are uncertain as to which counterbalance replacement swivel to order, refer to your original loading arm design drawing or contact the OPW Engineered Systems engineering department.



OPW Style 790 counterbalance swivel in upfeed right hand (UFRH) configuration shown.

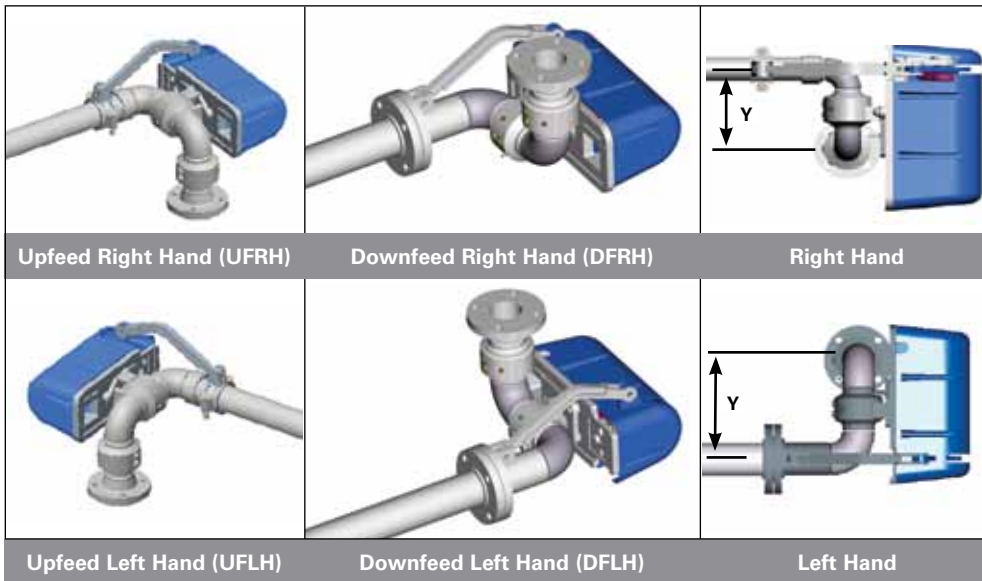

Maximum Y-dimensions: 2" size: Y= 8-1/8" (207 mm); 3" size: Y=11" (280 mm); 4" size: Y=12" (324 mm); and 6" size: Y=18" (470 mm).

## STYLE 56

Thread x Thread	Material	Model	Size (inches)	Dimensions
Style 56 (DFRH, UFLH)	Steel, Fabricated	3456	2, 3, 4	▲
	Stainless Steel, Fabricated	3956	2, 3, 4	▲
	Ductile Iron	3856	3, 4	●
Flange x Flange	Material	Model	Size (inches)	Dimensions
Style 56F (DFRH*)	Steel, Fabricated	3456F	2, 3, 4, 6	▲
	Stainless Steel, Fabricated	3956F	2, 3, 4, 6	▲
Flange x TTMA Flange	Material	Model	Size (inches)	Dimensions
Style 56FFT (DFRH*)	Steel, Fabricated	3456FFT	3, 4	▲
	Stainless Steel, Fabricated	3956FFT	3, 4	▲
Flange x Thread	Material	Model	Size (inches)	Dimensions
Style 56FO (DFRH, UFLH)	Steel, Fabricated	3456FO	2, 3, 4	▲
	Stainless Steel, Fabricated	3956FO	2, 3, 4	▲
	Ductile Iron	3856FO	2, 3, 4	●
Thread x TTMA Flange	Material	Model	Size (inches)	Dimensions
Style 56TFT (DFRH*)	Steel, Fabricated	3456TFT	3, 4	▲
	Stainless Steel, Fabricated	3956TFT	3, 4	▲

\*Left hand model available on special order. Consult factory.

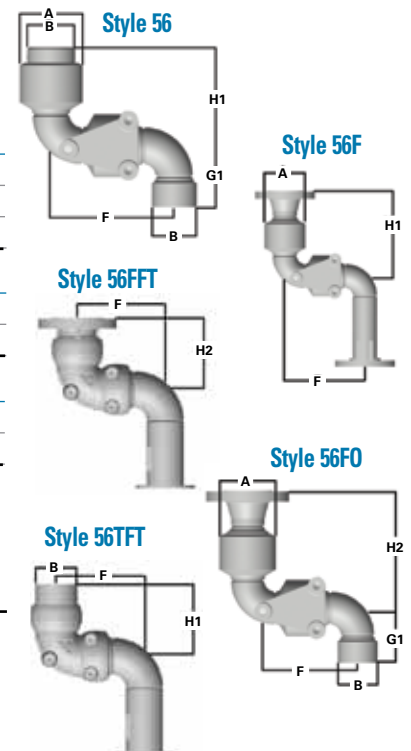

Dimensions Chart on page 20: ▲ Steel & Stainless Steel ● Aluminum, Ductile Iron & Bronze

## STYLE 58

Thread x Thread Style 58 (DFRH, UFLH)	Material	Model	Size (inches)	Dimensions
	Steel, Fabricated	3458	2, 3, 4	▲
	Stainless Steel, Fabricated	3958	2, 3, 4	▲
	Ductile Iron	3858	2, 3, 4	●

Flange x Flange Style 58F (DFRH*)	Material	Model	Size (inches)	Dimensions
	Steel, Fabricated	3458F	2, 3, 4, 6, 8, 10	▲
	Stainless Steel, Fabricated	3958F	2, 3, 4, 6, 8, 10	▲

Flange x TTMA Flange Style 58FFT (DFRH*)	Material	Model	Size (inches)	Dimensions
	Steel, Fabricated	3458FFT	3, 4	▲
	Stainless Steel, Fabricated	3958FFT	3, 4	▲

Flange x Thread Style 58FO (DFRH, UFLH)	Material	Model	Size (inches)	Dimensions
	Steel, Fabricated	3458FO	2, 3, 4	▲
	Stainless Steel, Fabricated	3958FO	2, 3, 4	▲
	Ductile Iron	3858FO	3, 4	●

Thread x TTMA Flange Style 58TFT (DFRH*)	Material	Model	Size (inches)	Dimensions
	Steel, Fabricated	3458TFT	3, 4	▲
	Stainless Steel, Fabricated	3958TFT	3, 4	▲

## STYLE 76

Flange x Flange Style 76F (DFRH*)	Material	Model	Size (inches)	Dimensions
	Steel, Fabricated	3476F	3, 4, 6	▲
	Stainless Steel, Fabricated	3976F	3, 4, 6	▲

Flange x TTMA Flange Style 76FFT (DFRH*)	Material	Model	Size (inches)	Dimensions
	Steel, Fabricated	3476FFT	3, 4	▲
	Stainless Steel, Fabricated	3976FFT	3, 4	▲

Flange x Thread Style 76FO (DFRH, UFLH)	Material	Model	Size (inches)	Dimensions
	Steel, Fabricated	3476FO	2, 3, 4	▲
	Stainless Steel, Fabricated	3976FO	2, 3, 4	▲
	Ductile Iron	3876FO	3, 4	●

## STYLE 78

Flange x Flange Style 78F (DFRH*)	Material	Model	Size (inches)	Dimensions
	Steel, Fabricated	3478F	2, 3, 4, 6	▲
	Stainless Steel, Fabricated	3978F	2, 3, 4, 6	▲

Flange x TTMA Flange Style 78FFT (DFRH*)	Material	Model	Size (inches)	Dimensions
	Steel, Fabricated	3478FFT	3, 4	▲
	Stainless Steel, Fabricated	3978FFT	3, 4	▲

Flange x Thread Style 78FO (DFRH, UFLH)	Material	Model	Size (inches)	Dimensions
	Steel, Fabricated	3478FO	2, 3, 4	▲
	Stainless Steel, Fabricated	3978FO	2, 3, 4	▲
	Ductile Iron	3878FO	3, 4	●

\* Left hand model available on special order. Consult factory.

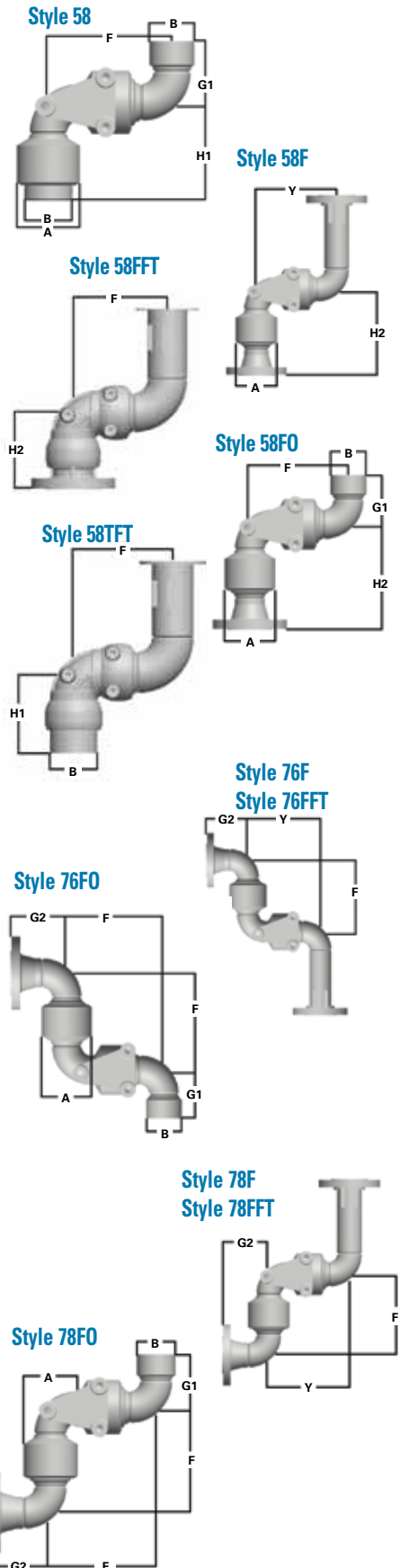

Dimensions Chart on page 20: ▲ Steel & Stainless Steel ● Aluminum, Ductile Iron & Bronze

**IMPORTANT:** OPW products should be used in compliance with applicable federal, state, provincial, and local laws and regulations. Product selection should be based on physical specifications and limitations and compatibility with the environment and materials to be handled. OPW MAKES NO WARRANTY OF FITNESS FOR A PARTICULAR USE. All illustrations and specifications in this literature are based on the latest product information available at the time of publication. OPW reserves the right to make changes at any time in prices, materials, specifications and models and to discontinue models without notice or obligation.

## SPECIALTY APPLICATIONS

### SPECIALTY SWIVEL JOINTS

OPW Engineered Systems specializes in the custom design and manufacture of swivel joints for special applications, including but not limited to:

- Hose reels
- Highway construction machinery
- Fire fighting equipment
- Machine tools
- Filtration equipment
- Aviation ground support equipment
- Tank trucks
- Plastics machinery
- Drum fillers
- Hydraulics

OPW engineers can help you determine the appropriate design for your special application by providing experienced consultation backed up by the right swivel design, tailored specifically to meet your application needs. OPW specialty swivels are available in a wide range of materials and sizes. Please contact the OPW Engineered Systems engineering department for assistance with your selection.

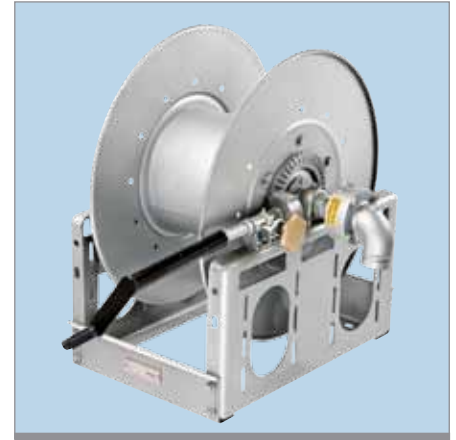

### HOSE REEL/VICTAULIC® SWIVELS

#### Thread x Victaulic® Groove Style 20VO

Material	Model	Size	Dimensions
Aluminum	2620-VO	1-1/2" x 2"	Use 1-1/2" ●
Cast Iron	2820-VO	1-1/2" x 2", 2" x 2"	Use 1-1/2", 2" ●
Aluminum	3620-VO	1-1/2" x 2", 2" x 2-1/2"	Use 1-1/2", 2" ●

#### Thread x Victaulic® Groove Style 30VO

Material	Model	Size	Dimensions
Aluminum	2630-VO	1-1/2" x 2"	Use 1-1/2" ●
Cast Iron	2830-VO	1-1/2" x 2", 2" x 2"	Use 1-1/2", 2" ●
Aluminum	3630VO	2", 3", 4"	Use 2", 3", 4" ●
Aluminum	3630VOG	1-1/2" x 2"	Use 1-1/2" ●

Available in Buna-N or Viton® seals.

#### Thread x Victaulic® Groove Style 3637VO

Material	Model	Size	Dimensions
Aluminum	3637VO	3" x 3"	see below*

\*A = 6-1/4" (159 mm); G1 = 3-7/8" (99 mm); H1 = 6-1/8" (156 mm)

OPW 3637VO is a 90° hose reel swivel with glass filament wound composite. Teflon® lined, sleeve-type bearings (not ball bearings). Available with Buna-N seals only. Pressure rating is 125 psi (9 kg/cm<sup>2</sup>). Also available in straight version: OPW 3627VO.

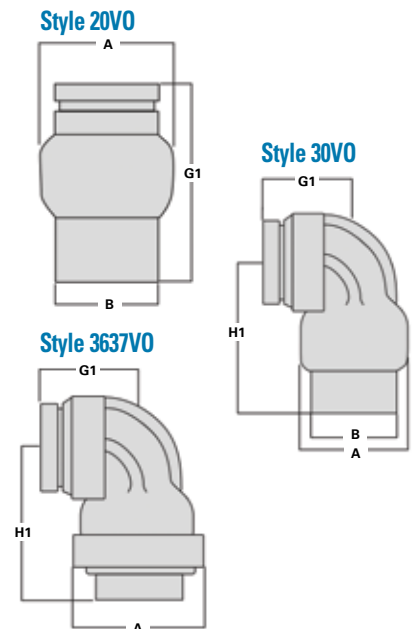

### JACKETED SWIVEL JOINTS

Any of OPW Engineered Systems fabricated steel or stainless steel swivels can be ordered jacketed. Jacketed swivels are commonly used in applications where relatively high temperatures must be maintained, such as asphalt, sulfur, waxes, and resins.

OPW jacketed swivels feature full steel jackets on the elbow portions only. Conductive heat from the jacketed elbows of the swivel joint provides sufficient heat to the seal area, which is generally field-insulated. For applications considered highly critical, the seal area of the joint can also be jacketed. Standard steam connections are 3/4" FNPT.

Mediums other than steam can also be re-circulated through OPW jacketed swivels to heat or cool products, such as oil, water, and glycol, among others.

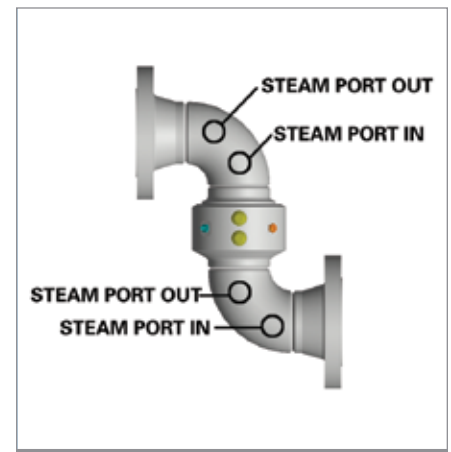

Dimensions Chart on page 20: ▲ Steel & Stainless Steel ● Aluminum, Ductile Iron & Bronze

# ENDURA™ DUAL SPLIT FLANGE SWIVELS

(8400 AND 8900 SERIES)

The OPW Engineered Systems ENDURA™ swivel line represents leading innovation in swivel technology. Specifically designed for the transfer of hazardous materials such as LPG, acids, solvents, petrochemicals and other toxic fluids, ENDURA™ sets the industry standard in swivel performance and cost-effective operation. Featuring heavy-duty flanged construction and available in a variety of materials.

## Benefits

**Endurance** – heavy-duty construction and unique design features result in long-life, hassle-free performance.

**Smooth, Easy Operation** – the sealed, one-piece deep-groove dual ball bearing assembly ensures smooth and easy rotation.

**Improves Uptime Performance** – the simple, three-piece design allows for the quickest and easiest disassembly and repair in the industry, which means less downtime, less labor, and less cost.

**Lowest Overall Cost of Ownership** – heavy-duty construction ensures long-life reliability while the unique design features allow for cost-effective preventive maintenance servicing and the easiest, most cost effective seal and bearing replacement of any swivel. Optimized performance, downtime prevention, and reduced maintenance time and costs make this the best overall swivel value in the industry.

**Ordering Chart see page 23.**



**IMPORTANT:** OPW products should be used in compliance with applicable federal, state, provincial, and local laws and regulations. Product selection should be based on physical specifications and limitations and compatibility with the environment and materials to be handled. OPW MAKES NO WARRANTY OF FITNESS FOR A PARTICULAR USE. All illustrations and specifications in this literature are based on the latest product information available at the time of publication. OPW reserves the right to make changes at any time in prices, materials, specifications and models and to discontinue models without notice or obligation.



## Features

**360° Rotation** – full range of motion for ease of use.

**Deep-Groove Replaceable Dual Ball Bearing Technology** – a precision-engineered, one-piece ball bearing assembly means there are no individual balls to deal with. If required, bearing replacement is quick and easy; simply replace the old bearing chamber with a new one. The ENDURA™ DSF 8900 Series features a 316 Stainless Steel replaceable dual ball bearing chamber.

**Redundant Seal System** - incorporates a main seal, back-up seal, environmental seal and leak detection. If the main seal ever leaks due to normal wear, the back-up seal contains the fluid. Leakage is then channeled to a leak detection port in the side of the swivel to provide a visual indicator that service is required so the seals can be replaced. The environmental seal provides a third layer of protection, preventing liquid from entering the environment. Seal materials include Buna-N, Viton®, EPT, Kalrez®, Chemraz®, Silicone, and Food Grade.

**Built-In Leak Detection** – a visual indicator, in the form of a leak detection port in the side of the swivel provides a quick and easy way to monitor seal leakage so preventive maintenance can be performed before a problem arises. The leak detection port can also serve as a purge port, permitting use of an inert blanket of gas to prevent product from escaping into the environment.

**Versatility** – available in 2", 3" and 4" sizes, and in a variety of construction materials, including carbon steel, stainless steel, Hastelloy®, Alloy20®, Monel® and other exotics.

**500 PSI Pressure Rating**

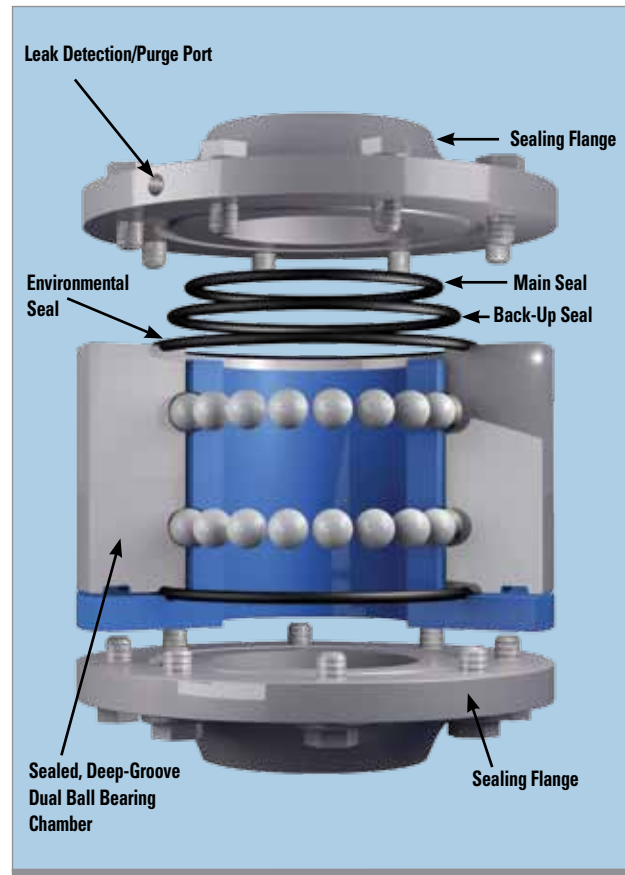

Supported boom-type loader with ENDURA™ dual split flange inlet swivel.

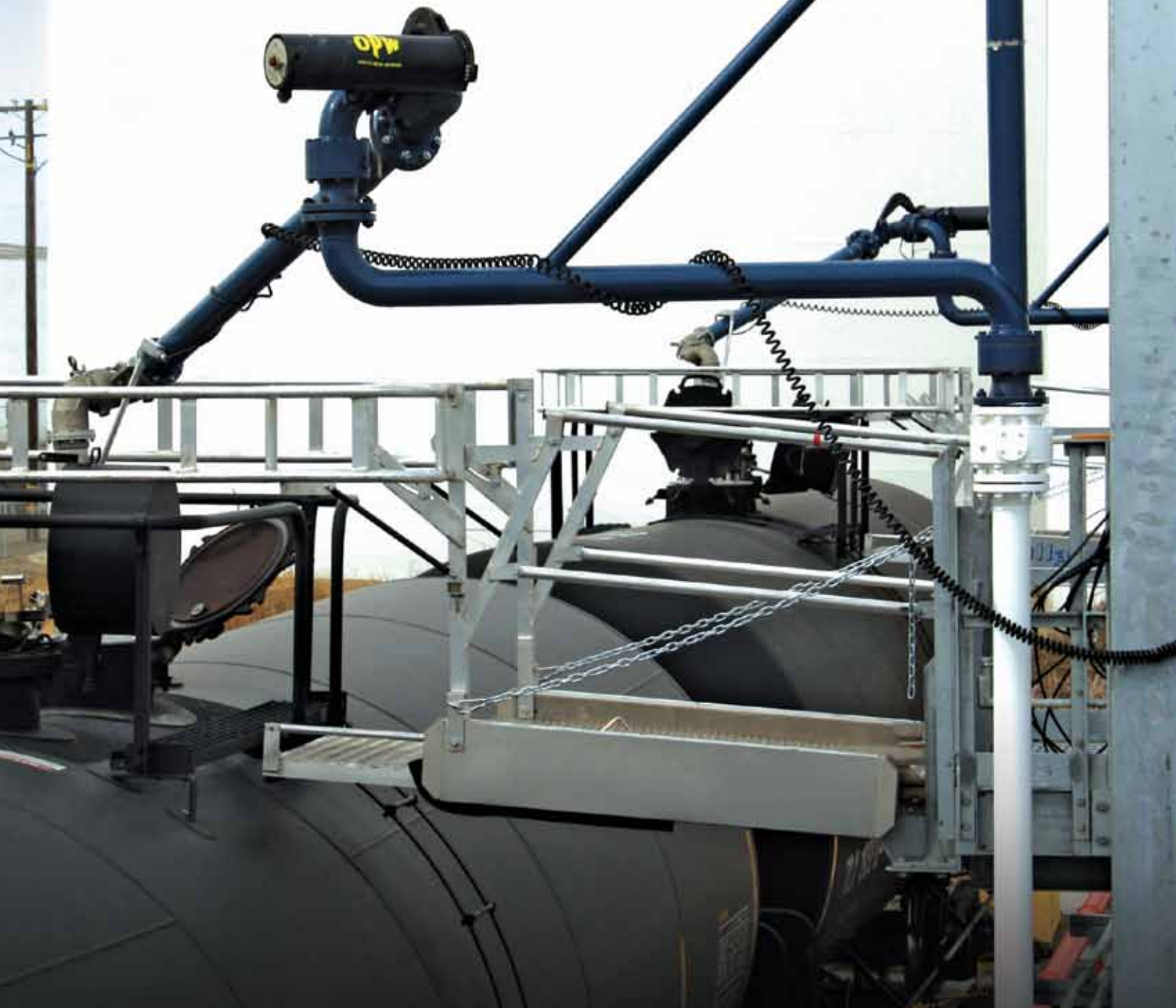

## REPAIR PARTS AND PROCEDURES

### SEAL REPLACEMENT KITS

OPW Engineered Systems has kits available to rebuild all swivel joints. The kits contain all the necessary parts to replace the wear parts. Before installing new seals, care should be taken to see that all machined surfaces are clean and that there are no nicks, scratches or burrs. Consult your local distributor for the proper kit.

Seal Material	Kit No.
Buna-N	3001-K
Viton®	3002-K
Teflon®	3003-K
EPT	3004-K
Neoprene	3005-K

### LUBRICANTS

OPW swivel joints should be lubricated periodically, depending on service and operating conditions. For normal operation, annually is sufficient. Frequent lubricating may be required when service is severe, such as high temperatures, heavy loads, or constant rotation.

#### Part #

#### Description

<b>880-0089</b>	High Performance Synthetic Lubricant 14 oz. (400 grams) cartridge
	<ul style="list-style-type: none"> <li>• Specially formulated to reduce friction and wear</li> <li>• Requires on y annual lubrication</li> <li>• Not for use with EPT/EPDM seals</li> <li>• Will not drip, melt or carbonize</li> <li>• Complies with FDA regulation 21CFR178.3570</li> <li>• Temperature range -40°F - 750°F ( -40°C - 398.8°C)</li> </ul>
<b>885-0085</b>	• High Performance Synthetic Lubricant for EPT Seals

**Warning:** EPT/EPDM Seals require the use of a OPW 885-0085 or a non-petroleum based lubricant.

### BALL BEARINGS

Both steel and stainless steel ball bearings are available for all OPW swivels. Each swivel plane of rotation has two races; quantities shown below are per pair of races.

Size (inches)	No. Balls Per Pair of Races	Part No. Steel Balls	Part No. Stainless Balls
3/4 & 1	40	H-7063-M <sup>1</sup>	H-30035-M
1-1/4 & 1-1/2	56	H-7063-M <sup>1</sup>	H-30035-M
2	48	H-6712-M <sup>2</sup>	H-1171-M
3	66	H-6712-M	H-1171-M
4	84	H-6712-M	H-1171-M
6	76	H-6780-M	H-30036-M
8	98	H-6780-M	H-30036-M
10	98	H-30162-M	H-30147-M

<sup>1</sup>3200 Series swivels use H-4577-M balls. <sup>2</sup>3200 Series swivels use H-4576-M balls.

### FLANGE DIMENSIONS

Type	Size (inches)	Flange O.D.		Bolt Circle		No. Bolt Holes	Bolt Dia.	
		in.	(mm)	in.	(mm)		in.	(mm)
150 lb. ASME	2	6	(153)	4-3/4	(121)	4	5/8	(16)
150 lb. ASME	3	7-1/2	(191)	6	(153)	4	5/8	(16)
TTMA	3	5-5/8	(143)	4-7/8	(124)	8	3/8	(10)
150 lb. ASME	4	9	(229)	7-1/2	(191)	8	5/8	(16)
TTMA	4	6-5/8	(169)	5-7/8	(150)	8	3/8	(10)
150 lb. ASME	6	11	(280)	9-1/2	(150)	8	3/4	(19)
150 lb. ASME	8	13-1/2	(343)	11-3/4	(242)	8	3/4	(19)
150 lb. ASME	10	16	(407)	17	(432)	12	7/8	(22)

Note: 300 lb., 600 lb., other types of flanges available on special order. Consult factory.

# DIMENSIONS

## ▲ Steel & Stainless Steel – U.S. (inches)

All dimensions are based on short radius elbows in 3/4" to 4" sizes; long radius elbows in 6", 8" and 10" sizes.

Size	A	B	D1	D2	D3	F	G1	G2	G3	H1	H2	H3	L
3/4	2-7/16	1-3/4	3-15/16				2-1/2			3-15/16			
1	2-7/16	1-3/4	3-15/16			4-5/16	2-1/2			3-15/16			
1-1/4	2-15/16	2-5/16	4-5/8				3			4-11/16			
1-1/2	2-15/16	2-5/16	4-5/8			4-3/4	3			4-11/16			
2	4-1/8	3-1/8	5-1/16	9-1/8	12-1/8	8-1/8	4-1/16	4-9/16	2	6-7/16	8-5/8	10-1/8	1-1/4
2	3-3/4	2-15/16	5-11/16			6-1/8	3-1/8			5-5/8			
3	5-1/8	4-1/4	5-7/8 <sup>a</sup>	10-1/4 <sup>a</sup>	12-3/4 <sup>a</sup>	10-3/4 <sup>a</sup>	5-1/16	5-13/16	3	8-1/8 <sup>a</sup>	10-1/2 <sup>a</sup>	11-3/4 <sup>a</sup>	1-1/2
4	6-1/4	5-5/16	6-3/8	10-3/4	12-3/4	12-3/4	6-5/16	7-1/16	4	9-7/16	11-3/4	12-3/4	2
6	9			13-7/16	14-7/16	24-7/16 <sup>b</sup>		12-9/16	9		18-15/16 <sup>c</sup>	19-7/16	2
8	11-7/8			16	16	32		16-1/16	12		24	24	
10	13-9/16			19-1/8	19-1/8	41-1/8		19-1/16	15		30-1/8	30-1/8	

Cast High-Pressure Steel only. A=Add 1/4" for Stainless Steel units. B=21 7/16" on styles 76F and 78F. C=15 15/16" on styles 56F and 58F.

## ● Aluminum, Ductile Iron, & Bronze – U.S. (inches)

All dimensions are based on short radius elbows.

Size	A	B	D1	D2	F	G1	G2	H1	H2	L
1	2-7/16	1-3/4	4-5/16 <sup>d</sup>		4-5/16	2-1/2		4-15/16 <sup>e</sup>		
1-1/2	2-15/16	2-3/8	4-5/8		4-3/4	3		4-11/16		
	3-3/4	2-15/16	5-11/16		6-1/8	3-1/8	5-1/2	5-5/8		1-1/4
3	4-7/8	4 <sup>d</sup>	6-5/8	6-5/8	7-5/8 <sup>e</sup>	4-5/8	5	6-7/8	6-7/8	1-1/2
4	6-1/16	5 <sup>e</sup>	7-3/16	7-5/8	9-1/4	5	6-1/16	7-11/16	8-1/8	2
6	9-1/8			9-15/16	14-1/8		7-3/4		12-7/8	

D=Aluminum is 4 11/16". E=Aluminum is 5 13/16". F=Ductile Iron is 3 15/16". G=10 3/8" on Aluminum model nos. 3640FTO and 3644FTO.

## ▲ Steel & Stainless Steel – Metric (mm)

All dimensions are based on short radius elbows in 3/4" to 4" sizes; long radius elbows in 6", 8" and 10" sizes.

Size	A	B	D1	D2	D3	F	G1	G2	G3	H1	H2	H3	L
3/4"	62	45	100				64			100			
1"	62	45	100			110	64			100			
1-1/4"	75	59	118				77			119			
1-1/2"	75	59	118			121	77			119			
2"	105	80	129	232	308	207	103	116	51	164	219	257	32
2"	96	75	145			156	80			143			38
3"	131	108	150 <sup>a</sup>	261 <sup>a</sup>	324 <sup>a</sup>	273 <sup>a</sup>	129	148	77		267 <sup>a</sup>	299 <sup>a</sup>	51
4"	159	135	162	273	324	324	161	180	102	207 <sup>a</sup>	299	324	51
6"	229			342	367	621 <sup>b</sup>		319	229	240	481 <sup>c</sup>	494	
8"	302			407	407	813		408	305		610	610	
10"	345			486	486	1045		485	381		765	765	

Cast High-Pressure Steel only. A=Add 1/4" for Stainless Steel units. B=21 7/16" on styles 76F and 78F. C= 15 15/16" on styles 56F and 58F.

## ● Aluminum, Ductile Iron, & Bronze – Metric (mm)

All dimensions are based on short radius elbows.

Size	A	B	D1	D2	F	G1	G2	H1	H2	L
1"	62	45	110 <sup>d</sup>		110	64		126 <sup>e</sup>		
1-1/2"	75	60	118		121	77		119		
2"	96	75	145		156	80	140	143		32
3"	124	102 <sup>a</sup>	169	169	194 <sup>a</sup>	118	127	175	175	38
4"	154	127 <sup>a</sup>	183	194	235	127	154	196	207	51
6"	232			253	359		197		327	

D=Aluminum is 4-11/16". E= Aluminum is 5-13/16". F=Ductile Iron is 3-15/16". G=10 3/8" on Aluminum model nos. 3640FTO and 3644FTO.

**IMPORTANT:** OPW products should be used in compliance with applicable federal, state, provincial, and local laws and regulations. Product selection should be based on physical specifications and limitations and compatibility with the environment and materials to be handled. OPW MAKES NO WARRANTY OF FITNESS FOR A PARTICULAR USE. All illustrations and specifications in this literature are based on the latest product information available at the time of publication. OPW reserves the right to make changes at any time in prices, materials, specifications and models and to discontinue models without notice or obligation.

## APPROXIMATE WEIGHTS (EXCEPT ENDURA™ SERIES)

### Threaded Ends (inches)

Style		3/4 & 1-1/2	1-1/4 & 1-1/2	2	3	4
20	lbs.	3 lbs.	4	8	15	22
	kgs	1	2	4	7	10
30	lbs.	4 lbs.	5	9	18	24
	kgs	2 kg	2	4	8	11
40	lbs.	5 lbs.	6	11	23	34
	kgs	2 kg	3	5	10	15
50	lbs.	8 lbs.	9	16	35	48
	kgs	4 kg	4	7	16	22
60	lbs.	7 lbs.	8	14	30	38
	kgs	3 kg	4	6	14	17
70	lbs.	9 lbs.	10	18	40	58
	kgs	4 kg	5	8	18	26
80	lbs.			22	50	70
	kgs			10	23	32
10	lbs.			20	47	64
	kgs			9	22	29

### Flanged Ends (inches)

Style		2	3	4	6	8	10
20F	lbs.	20lbs.	37	49	95	210	265
	kgs	9 kg	17	22	43	95	120
30F	lbs.	21 lbs.	40	56	112	245	315
	kgs	10 kg	18	25	51	111	143
40F	lbs.	23 lbs.	43	62	128	275	380
	kgs	10 kg	20	28	58	125	172
50F	lbs.	28 lbs.	56	78	169	415	525
	kgs	13 kg	25	35	77	188	238
60F	lbs.	26 lbs.	53	70	153	365	435
	kgs	12 kg	24	32	69	166	197
70F	lbs.	30 lbs.	60	85	186	465	615
	kgs	14 kg	27	39	84	211	279
80F	lbs.	35 lbs.	72	100	225	580	735
	kgs	16 kg	33	45	102	263	33
10F	lbs.	34 lbs.	70	95	203	530	645
	kgs	15 kg	32	43	92	240	293

Weights shown are for steel and stainless steel swivels. Multiply table value by .30 for approximate weights of aluminum swivels. Multiply table value by .90 for approximate weights of ductile iron and bronze swivels.

## SPECIFICATIONS

All OPW swivel joints are full bore schedule 40 construction with short radius elbows, except 6", 8", and 10" fabricated steel and stainless steel swivels which have long radius elbows. Ball bearing raceways and sealing surfaces in all swivels are precision machined and micro-finished to assure friction-free operation and superior sealing characteristics. All steel and ductile iron swivels are painted blue. Detailed specifications by series are as follows:

### 3200 Series (Cast Steel, High-Pressure)

Bodies and tails of cast 1040 carbon steel with hardened raceways. Ball bearings are precision-ground steel. Buna-N main O-ring seal with Teflon® back-up ring, and Buna-N O-ring dust seal are standard.

### 3300 Series (Cast Bronze)

Bodies and tails of hard, wear-resistant cast bronze (ASTM B62-83600). Precision-ground steel balls, Buna-N O-ring main seal and felt dust seal are standard. 1" size has Buna-N O-ring dust seal.

### 3400 Series (Fabricated Steel)

Bodies and tails of 1040 carbon steel with hardened raceways. Welded construction; 100% penetration welding by welders certified to ASME Boiler and Pressure Vessel Code, Section IX. Precision-ground steel balls, Buna-N O-ring main seal, Buna-N O-ring dust seal. Standard flanges are ASME 150 lb. raised face type.

### 3600 Series (Cast Aluminum)

Bodies and tails of cast A-356 high-tensile strength aluminum. Precision-ground steel balls, Buna-N O-ring main seal, and felt dust seal are standard. 1" size has Buna-N O-ring dust seal. Flanges are dimensionally compatible to ASME 150 lb. flat face configuration.

### 3700 Series (Cast Stainless Steel)

Bodies and tails of high quality cast ASTM A351-CF3M/CF8M stainless steel. Precision-ground stainless steel balls, Buna-N O-ring main seal and Buna-N O-ring dust seal.

### 3800 Series (Cast Ductile Iron)

Bodies and tails of cast A-536 ductile iron. Precision-ground steel balls, Buna-N O-ring main seal, and felt dust seal are standard. Buna-N O-ring dust seal standard in 1" size. ASME B16.1, Class 125 dimensionally equal to 150lb. ASME RF Flange.

### 3900 Series (Fabricated Stainless Steel)

Bodies and tails of high-quality ASTM A351-CF3M/CF8M stainless steel. Welded construction; 100% penetration welding by welders certified to ASME Boiler and Pressure Vessel Code, Section IX. Precision-ground stainless steel ball bearings, Buna-N O-ring main seal, Buna-N O-ring dust seal. Standard flanges are ASME 150 lb. raised face type.

Refer to the Pressure/Temperature chart on page 5 to choose the proper seal and body material for the swivel you need. Or, if you have a special application and are unable to locate the particular swivel you have in mind, please contact your local OPW Engineered Systems representative or the factory for assistance.

# Endura...™

The world's most advanced swivel



8420F

Endura Dual Split-Flange (DSF) Swivels—360° rotation with built-in leak detection, plus durability, reliability and easy maintenance.

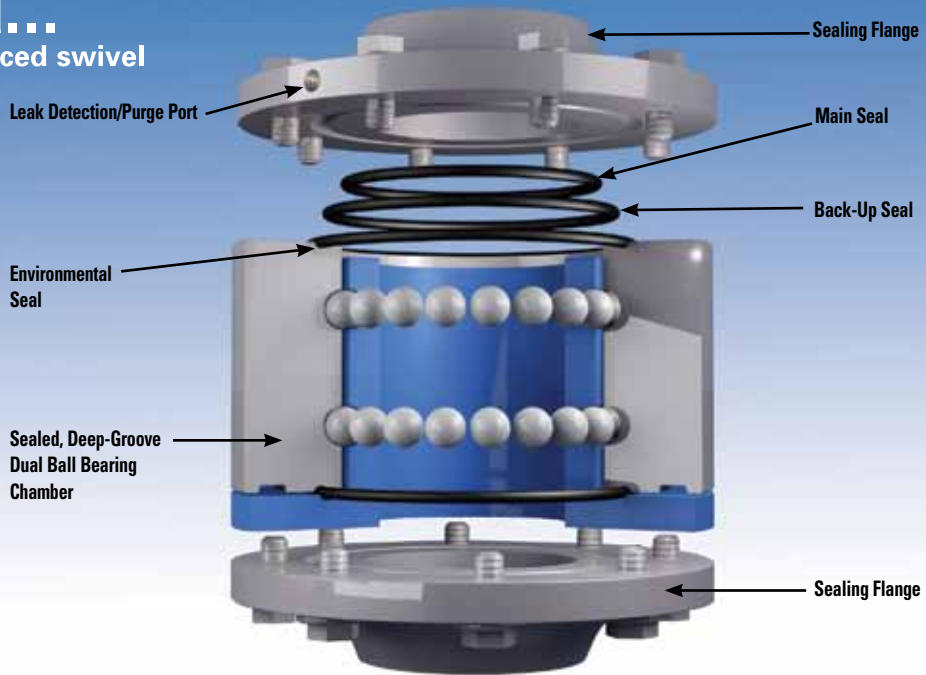

## OPW SWIVEL JOINTS

Your guide to the industry's most complete line of swivels.

**Selected Swivel Designs:** Call OPW Customer Service at 800-547-9393 for complete information on products and applications.

▼ 3730 Cast SST, Style 30, Female NPT



▶ 3910 Fabricated SST, Style 10, Female NPT



▼ 3920 F Fabricated SST, Style 20F, 150 Lb. Flange



▶ 3960 FO Fabricated SST, Style 60FO, 150 Lb. Flange x Female NPT



▶ 3740 Cast SST, Style 40, Female NPT



▶ 3970 W Fabricated SST, Style 70W, Beveled for Welding



▶ 3630 VO Cast Aluminum, Style 30VO, Female NPT x Victaulic® Groove



▶ 3980 Fabricated SST, Style 80, Female NPT

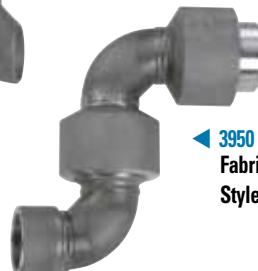

▶ 3950 Fabricated SST, Style 50, Female NPT



▶ 3330 Cast Bronze, Style 30, Female NPT

**IMPORTANT:** OPW products should be used in compliance with applicable federal, state, provincial, and local laws and regulations. Product selection should be based on physical specifications and limitations and compatibility with the environment and materials to be handled. OPW MAKES NO WARRANTY OF FITNESS FOR A PARTICULAR USE. All illustrations and specifications in this literature are based on the latest product information available at the time of publication. OPW reserves the right to make changes at any time in prices, materials, specifications and models and to discontinue models without notice or obligation.

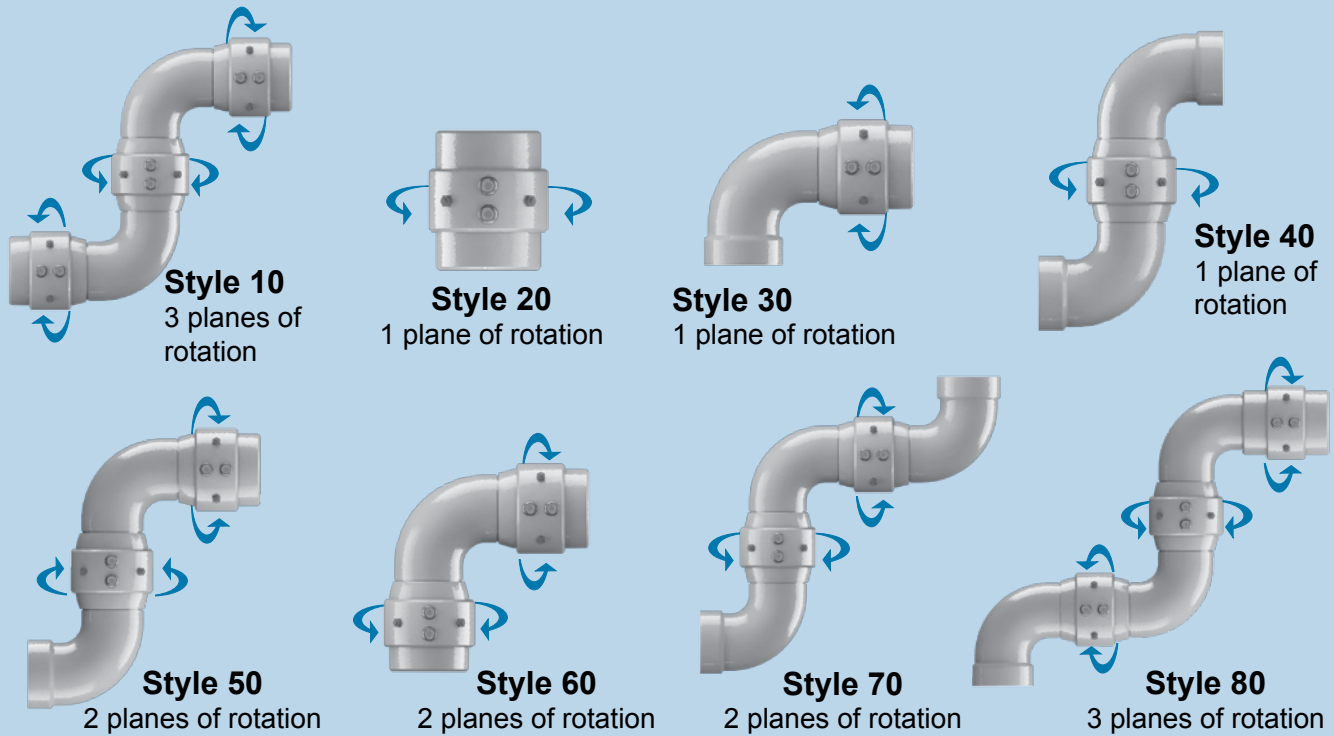

**Ordering Chart:** Call OPW Customer Service at **800-547-9393** for complete ordering information.

Style 44 is drop tube swivel w/handle. Styles 35, 45, 55 have threaded boss. Styles 56, 58, 76, 78 have spring balance attachment lugs.

Style (Planes of Rotation)

**3 4 2 0 F - 0 4 0 3**

**Seal Materials**

- 1 - Buna-N (Standard)
- 2 - Fluorocarbon
- 3 - PTFE
- 4 - EPDM
- 5 - Food Grade Nitrile

Kalrez<sup>®</sup>, Chemraz<sup>®</sup> and other seal materials available.

**Construction**

- Conventional Hose** 26 - Aluminum Hose Reel
- Reel Swivels** 28 - Ductile Iron Hose Reel
- 32 - Steel, High Pressure Cast
- 33 - Bronze
- 34 - Steel, Fabricated
- Conventional Swivels** 36 - Aluminum
- 37 - 316 Stainless Steel, Cast
- 38 - Ductile Iron
- 39 - 316 Stainless Steel, Fabricated
- Endura™ DSF Split Flange Swivels** 82 - Steel Endura™ DSF Single Race
- 84 - Steel Endura™ DSF Dual Race
- 87 - 316 SST Endura™ DSF Single Race
- 89 - 316 SST Endura™ DSF Dual Race

Alloy20<sup>®</sup>, Hastelloy<sup>®</sup>, Monel<sup>®</sup>, Duplex, PTFE-lined and other materials available.

**End Connections**

- F - 150 lb. ASME flange both ends
- FFT - 150 lb. ASME flange inlet x TTMA tank truck flange outlet
- FJ - For submerged use, 150 lb. ASME flange both ends
- FO - 150 lb. flange x female NPT threads
- FSB - 150 lb. flange both ends, with spring balance attachment lugs
- FT - TTMA tank truck flange both ends
- FTH - TTMA tank truck flange both ends, with female
- VO - Victaulic<sup>®</sup> x female NPT threads
- FTO - TTMA tank truck flange inlet x female NPT threaded outlet
- J - For submerged use
- LFT - Long swivel joint with TTMA tank truck flanges
- TFT - Female NPT threaded inlet x TTMA tank truck flange outlet
- VOG - Female NPT threads x Victaulic<sup>®</sup> groove, hard coat anodized aluminum
- W - Beveled for welding both ends

NO SUFFIX LETTER (S) indicates Female NPT threads both ends. 300 lb. flanges available on some models. BSPT threads available.

**Size**

- 007 - 3/4"
- 010 - 1"
- 012 - 1-1/4"
- 015 - 1-1/2"
- 020 - 2"
- 030 - 3"
- 040 - 4"
- 060 - 6"
- 080 - 8"
- 100 - 10"
- 120 - 12"

Availability of styles, sizes and materials may vary depending upon swivel configuration. Consult OPW Customer Service regarding your exact requirements.

OPW Fluid Transfer Group (OPWFTG), part of Dover Corporation (NYSE:DOV), is comprised of market-leading operating companies, each dedicated to designing, manufacturing and distributing world-class solutions for the safe handling and transporting of hazardous bulk products. In addition to these companies, OPWFTG has manufacturing plants in North America, Europe, Brazil and India; and sales offices in Singapore, and China.

Throughout the world, OPWFTG companies are hard at work ensuring the safe processing, loading, transporting and unloading of hazardous bulk products and safeguarding against costly petroleum and chemical spills, tank overfills and fugitive vapor emissions. Whether your need is in the chemical plant, at the terminal loading rack, or outfitting a fleet of rail tank cars, cargo tanks or dry-bulk trailers, OPWFTG systems set the standard for safety, performance and peace-of-mind assurance in the most rigorous and demanding applications. If the safe, profitable handling of hazardous liquids and dry bulk commodities such as gasoline and diesel, chlorine, chlor-alkali products, LPG, acids, cement, flour and starch, among others, is your concern, trust OPWFTG.

**EXPERT SOLUTIONS FOR THE SAFE HANDLING & TRANSPORTING OF HAZARDOUS BULK PRODUCTS**

	Applications	Processing	Load	Transporting		Unload
<b>PETROLEUM</b>	<ul style="list-style-type: none"> <li>Gasoline</li> <li>Ethanol</li> <li>Alcohols</li> <li>Fuel Oil</li> <li>LPG</li> <li>Diesel</li> <li>Biodiesel</li> </ul>	<ul style="list-style-type: none"> <li>Bellow Sealed Valves</li> <li>Sample Valves</li> <li>Lined Ball Valves</li> <li>Lined Butterfly Valves</li> <li>Industrial Valves</li> <li>ISO Rings</li> <li>Sight Flow Indicators</li> <li>Globe Valves</li> <li>Swivels</li> <li>Dry Disconnects</li> </ul>	<ul style="list-style-type: none"> <li>Loading Arms</li> <li>Couplers</li> <li>Rack Monitors</li> <li>Dry Disconnects</li> <li>API Coupler</li> <li>Swivels</li> </ul>	<b>Cargo Tanks</b> <ul style="list-style-type: none"> <li>Manholes</li> <li>Vapor Vents</li> <li>Electronics</li> <li>Internal Valves</li> <li>API Adaptors</li> <li>Sealed Parcel Controls</li> <li>Manifold Systems</li> </ul>	<b>Rail Tank Cars</b> <ul style="list-style-type: none"> <li>Pressure Relief Valves</li> <li>Plug Valves</li> <li>Ball Valves</li> <li>Level Measurement</li> <li>Autoloks</li> <li>Kamvaloks</li> <li>Dryloks</li> <li>Rupture Disc Devices</li> <li>Angle Valves</li> </ul>	<ul style="list-style-type: none"> <li>Drylok Couplers</li> <li>Adaptors</li> <li>Delivery Elbows</li> <li>Vapor Recovery Elbows</li> <li>Swivels</li> </ul>
<b>CHEMICALS</b>	<ul style="list-style-type: none"> <li>Chlorine</li> <li>Acids &amp; Bases</li> <li>Amines</li> <li>Anhydrous Ammonia</li> <li>Propylene</li> <li>Butadiene</li> <li>Hazardous Liquids</li> </ul>	<ul style="list-style-type: none"> <li>Bellow Sealed Valves</li> <li>Sample Valves</li> <li>Lined Ball Valves</li> <li>Lined Butterfly Valves</li> <li>Industrial Valves</li> <li>ISO Rings</li> <li>Sight Flow Indicators</li> <li>Globe Valves</li> <li>Swivels</li> <li>Dry Disconnects</li> <li>Quick Disconnects</li> <li>Epsilon</li> </ul>	<ul style="list-style-type: none"> <li>Loading Arms</li> <li>Autoloks</li> <li>Kamvaloks</li> <li>Dryloks</li> <li>Loading Manholes</li> <li>Valves</li> <li>Actuators</li> <li>Swivels</li> <li>Epsilon</li> </ul>	<b>Cargo Tanks</b> <ul style="list-style-type: none"> <li>Manholes</li> <li>Vapor Vents</li> <li>Electronics</li> <li>Internal Valves</li> <li>Sealed Parcel</li> <li>Epsilon</li> </ul>	<b>Rail Tank Cars</b> <ul style="list-style-type: none"> <li>Safety Valves</li> <li>Plug Valves</li> <li>Ball Valves</li> <li>Level Measurement</li> <li>Autoloks</li> <li>Kamvaloks</li> <li>Dryloks</li> <li>Rupture Disc Devices</li> <li>Angle Valves</li> <li>Epsilon</li> </ul>	<ul style="list-style-type: none"> <li>Loading Arms</li> <li>Autoloks</li> <li>Kamvaloks</li> <li>Dryloks</li> <li>Valves</li> <li>Actuators</li> <li>Safety Breakaways</li> <li>Swivels</li> <li>Epsilon</li> </ul>
<b>DRY BULK</b>	<ul style="list-style-type: none"> <li>Cement</li> <li>Flour/Starch</li> <li>Pharmaceuticals</li> </ul>	<ul style="list-style-type: none"> <li>Industrial Valves</li> <li>Sight Flow Indicators</li> <li>Butterfly Valves</li> <li>Swivels</li> </ul>	<ul style="list-style-type: none"> <li>Loading Arms</li> <li>Aerators</li> <li>Hatch Covers</li> <li>Swivels</li> </ul>	<b>Cargo Tanks</b> <ul style="list-style-type: none"> <li>Manholes</li> <li>Check Valves</li> <li>Hopper Tees</li> <li>Butterfly Valves</li> <li>Aerators</li> <li>Weld Rings</li> </ul>	<b>Railcars</b> <ul style="list-style-type: none"> <li>Manholes</li> <li>Hatches</li> <li>Access Ports</li> <li>Check Valves</li> <li>Hopper Tees</li> <li>Butterfly Valves</li> <li>Aerators</li> <li>Pressure Vacuum Valves</li> </ul>	<ul style="list-style-type: none"> <li>Aerators</li> <li>Butterfly Valves</li> <li>Tank Hatches</li> <li>Pressure Relief</li> <li>Vacuum Relief</li> <li>Temperature Monitoring</li> </ul>
<b>INDUSTRIAL/GENERAL</b>	<ul style="list-style-type: none"> <li>Food Processing</li> <li>Pharmaceuticals</li> <li>Waste Water</li> <li>High-Purity Liquids</li> <li>Breweries</li> <li>Pulp and Paper</li> <li>Steel Processing</li> </ul>	<ul style="list-style-type: none"> <li>Lined Ball Valves</li> <li>Lined Butterfly Valves</li> <li>Sample Systems</li> <li>Sight Flow Indicators</li> <li>ISO Rings</li> <li>Dry Disconnects</li> <li>Swivels</li> <li>Quick Disconnects</li> <li>High-Performance Butterfly Valves</li> <li>Epsilon</li> </ul>	<ul style="list-style-type: none"> <li>Loading Arms</li> <li>Couplers</li> <li>Rack Monitors</li> <li>Swivels</li> <li>Dry Disconnects</li> <li>Quick Disconnects</li> <li>Butterfly Valves</li> <li>Epsilon</li> </ul>	<b>Cargo Tanks</b> <ul style="list-style-type: none"> <li>Manholes</li> <li>Vapor Vents</li> <li>Electronics</li> <li>Weld Rings</li> <li>Hopper Tees</li> <li>Pneumatic Controls</li> <li>Sealed Parcel</li> <li>Dry Disconnects</li> <li>Epsilon</li> </ul>	<b>Rail Tank Cars</b> <ul style="list-style-type: none"> <li>Safety Valves</li> <li>Plug Valves</li> <li>Ball Valves</li> <li>Level Measurement</li> <li>Autoloks</li> <li>Kamvaloks</li> <li>Dryloks</li> <li>Rupture Disc Devices</li> <li>Angle Valves</li> <li>Epsilon</li> </ul>	<ul style="list-style-type: none"> <li>Loading Arms</li> <li>Couplers</li> <li>Rack Monitors</li> <li>Swivels</li> <li>Dry Disconnects</li> <li>Quick Disconnects</li> <li>Butterfly Valves</li> <li>Epsilon</li> </ul>

**Chemical & Industrial Processing Market Unit**

- Food Processing
- Chemical Plants
- Petroleum Loading Stations
- Steel Processing, Pulp & Paper
- Waste Water Treatment
- Pharmaceutical
- Breweries
- High-Purity Liquids
- Ethanol Processing
- Biodiesel Processing

**Rail Market Unit**

- Pressure & General Purpose Rail Tank Cars
- Dry Bulk Railcars
- Ethanol Rail Tank Cars
- Diesel
- Biodiesel

**Cargo Tank Market Unit**

- Gasoline & Diesel
- Dry Bulk
- Ethanol
- Biodiesel

**INDIA**

36 Marol Co-op. Ind. Est. Ltd.  
2nd Floor, M.V. Road., Marol  
Andheri (E), Mumbai – 400 059  
Tel: +91 22 2851 7296, 91 22 2851 7355  
Fax: +91 22 2851 7333  
www.opwftgindia.com

**ASIA PACIFIC**

Telephone: +65 9679 1762

**SURE SEAL** 2726 Henkle Drive  
Lebanon, OH 45306 USA  
Telephone: +1 513 696 1500  
Fax: +1 513 932 9845

**SOUTH AMERICA**

Rua Manuel Augusto de Alvarenga, 155  
São Paulo, São Paulo, Brazil  
CEP 04402-050  
Telephone: +55 11 5564 6466  
Fax: +55 11 5679 7960  
www.opwftg.com.br

**EUROPE**

Roggestraat 38, 2153 GC Nieuw-Vennep  
P.O. Box 32, 2150 AA Nieuw-Vennep  
The Netherlands  
Telephone: +31 252 660 300  
Fax: +31 252 687 258  
www.opwftg.nl



4304 Mattox Road  
Kansas City, MO 64150 USA  
Telephone: +1 816 741 6600  
Fax: +1 816 741 1061  
www.civacon.com

**CHINA**

Suite 25 B, Suntime  
International Mansion  
450 Fushan Road,  
Shanghai, China 200122  
Tel: +011 86 21 5830 7595  
Fax: +011 86 21 5830 7535  
www.opwftgchina.com

**UNITED STATES**

4680 Parkway Dr., Suite 203  
Mason, Ohio 45040 USA  
Telephone: +1 513 696 1798  
Fax: +1 513 204 5770  
www.opwftg.com



7733 Gross Point Road  
Skokie, IL 60077 USA  
Telephone: +1 847 677 0333  
Fax: +1 847 677 0138  
www.midlandmfg.com

Distributed By:



PHONE: (800) 547-9393 • (513) 696-1500 • Fax: (800) 245-8536 • (513) 932-9845  
2726 Henkle Drive • Lebanon, OH 45036 • www.opw-es.com